

锁牙式钨钢立铣刀头

Modular Carbide Endmills

车削系列 Turning Series

铣削系列 Milling Series

搪系列 Fine Broing Series

车削系列 Turning Series

铣削系列 Milling Series

搪系列 Fine Broing Series



型号说明 Item Code Description

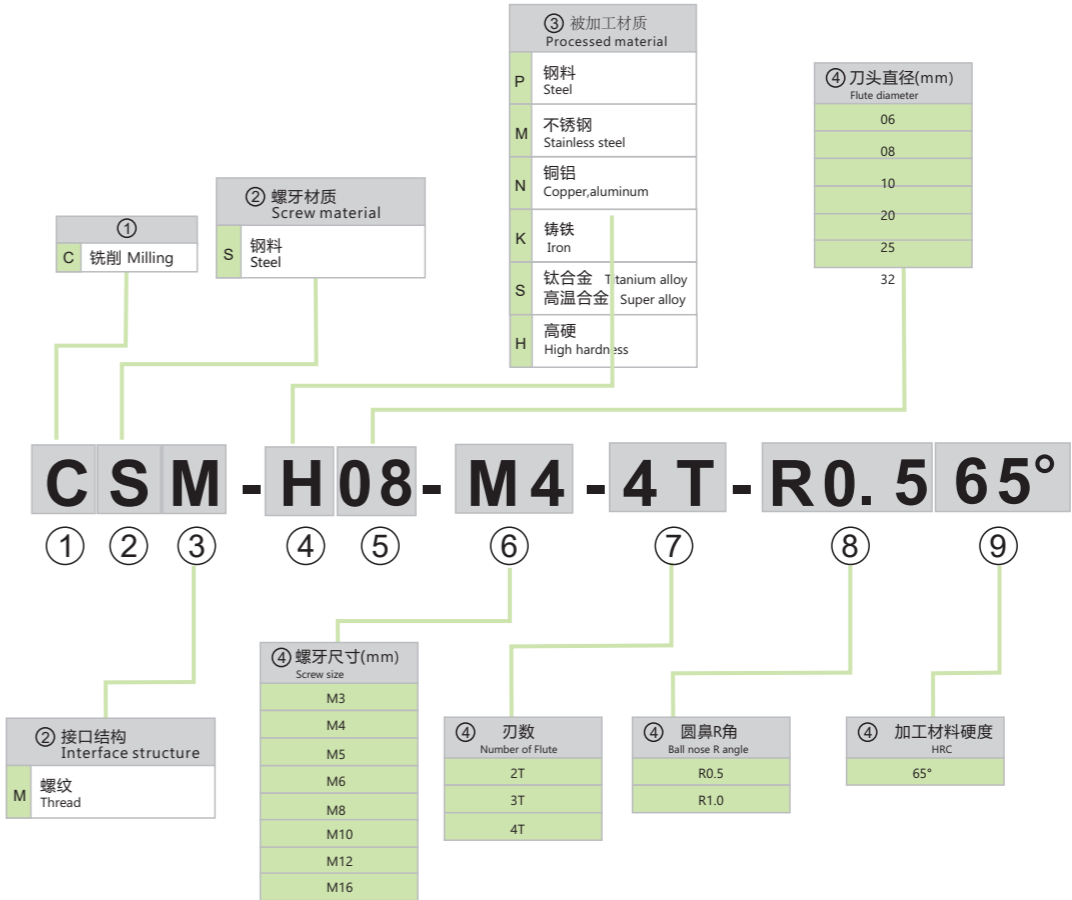

锁牙式钨钢立铣刀头铝用

Indexable Modular Carbide Endmill 65°

平刀CSM-N系列

Flat Cutter CSM-N Series

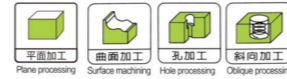
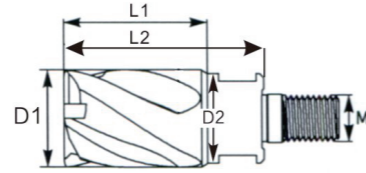

规格型号 Item code	尺寸毫米 Dimensions(mm)					扳手型号 Wrench	备货情况 Inventory	重量 Weight(kg)
	D1	L1	D2	L2	M			
CSM-N08-M4-3T	8	15.7	7.8	20	M4	K06	●	0.01
CSM-N10-M5-3T	10	15.7	9.8	23	M5	K08	●	0.02
CSM-N12-M6-3T	12	18.0	11.7	25	M6	K10	●	0.035
CSM-N16-M8-3T	16	22.0	15.6	29	M8	K13	●	0.06
CSM-N20-M10-3T	20	22.0	19.5	36	M10	K17	●	0.12
CSM-N25-M12-3T	25	25.0	24.4	41	M12	K22	●	0.23

注Note: ●现货Spot, △交货时间短Short delivery time, ○交货时间长Long delivery time.

圆鼻刀CSM-N系列

Ball Cutter CSM-H Series

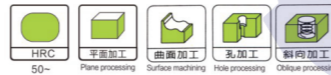
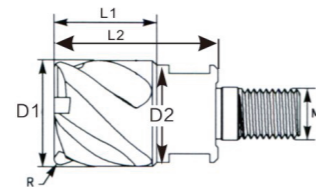

规格型号 Item code	尺寸毫米 Dimensions(mm)						扳手型号 Wrench	备货情况 Inventory	重量 Weight(kg)
	D1	L1	D2	L2	M	R			
CSM-N08-M4-3T-R0.5	8	15.7	7.8	20	M4	0.5	K06	○	0.01
CSM-N10-M5-3T-R0.5	10	15.7	9.8	23	M5	0.5	K08	○	0.02
CSM-N12-M6-3T-R0.5	12	18.0	11.7	25	M6	0.5	K10	○	0.035
CSM-N16-M8-3T-R0.5	16	22.0	15.6	29	M8	0.5	K13	○	0.06
CSM-N20-M10-3T-R0.5	20	22.0	19.5	36	M10	0.5	K17	○	0.12
CSM-N08-M4-3T-R1.0	8	15.7	7.8	20	M4	1.0	K06	○	0.01
CSM-N10-M6-3T-R1.0	10	15.7	9.8	23	M5	1.0	K08	○	0.02
CSM-N12-M6-3T-R1.0	12	18.0	11.7	25	M6	1.0	K10	○	0.035
CSM-N16-M8-3T-R1.0	16	22.0	15.6	29	M8	1.0	K13	○	0.06
CSM-N20-M10-3T-R1.0	20	22.0	19.5	36	M10	1.0	K17	○	0.12

注Note: ●现货Spot, △交货时间短Short delivery time, ○交货时间长Long delivery time.

锁牙式钨钢立铣刀头铝用

Indexable Modular Carbide Endmill 65°

球刀CSM-N系列

Flat Cutter CSM-H Series

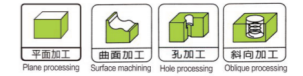
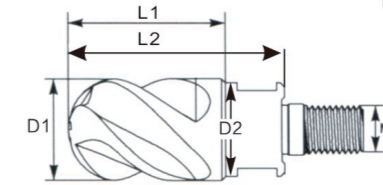

规格型号 Item code	尺寸毫米 Dimensions(mm)					扳手型号 Wrench	备货情况 Inventory	重量 Weight(kg)
	D1	D2	L1	L2	M			
CSM-NR4-M4-2T	R4.0	7.8	15.7	20	M4	K6	●	0.01
CSM-NR5-M5-2T	R5.0	9.8	15.7	23	M5	K8	●	0.02
CSM-NR6-M6-2T	R6.0	11.7	18.0	25	M6	K10	●	0.035
CSM-NR8-M8-2T	R8.0	15.6	22.0	29	M8	K13	●	0.06
CSM-NR10-M10-2T	R10.0	19.5	22.0	36	M10	K17	●	0.12
CSM-NR12.5-M12-2T	R12.5	24.4	25.0	41	M12	K22	●	0.23

注Note: ●现货Spot, △交货时间短Short delivery time, ○交货时间长Long delivery time.

锁牙式钨钢立铣刀头65°

Indexable Modular Carbide Endmill 65°

平刀CSM-H系列

Flat Cutter CSM-H Series

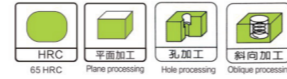
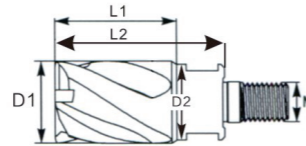

规格型号 Item code	尺寸毫米 Dimensions(mm)					扳手型号 Wrench	备货情况 Inventory	重量 Weight(kg)
	D1	D2	L1	L2	M			
CSM-H08-M4-4T 65°	8	7.8	15.7	20	M4	K06	●	0.01
CSM-H10-M5-4T 65°	10	9.8	15.7	23	M5	K08	●	0.02
CSM-H12-M6-4T 65°	12	11.7	18.0	25	M6	K10	●	0.035
CSM-H16-M8-4T 65°	16	15.6	22.0	29	M8	K13	●	0.06
CSM-H20-M10-4T 65°	20	19.5	22.0	36	M10	K17	●	0.12
CSM-H25-M12-4T 65°	25	24.4	25	41	M12	K22	●	0.23

注Note: ●现货Spot, △交货时间短Short delivery time, O交货时间长Long delivery time.

球刀CSM-H系列

Ball Cutter CSM-H Series

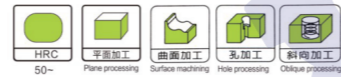
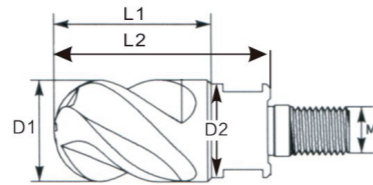

规格型号 Item code	D1	尺寸毫米 Dimensions(mm)			M	扳手型号 Wrench	备货情况 Inventory	重量 Weight(kg)
		L1	D2	L2				
CSM-HR4-M4-2T 65°	R4.0	15.7	7.8	20	M4	K06	●	0.01
CSM-HR5-M5-2T 65°	R5.0	15.7	9.8	23	M5	K08	●	0.02
CSM-HR6-M6-2T 65°	R6.0	18.0	11.7	25	M6	K10	●	0.035
CSM-HR8-M8-2T 65°	R8.0	22.0	15.6	29	M8	K13	●	0.06
CSM-HR10-M10-2T 65°	R10.0	22.0	19.5	36	M10	K17	●	0.12
CSM-HR12.5-M12-2T 65°	R12.5	25.0	24.4	41	M12	K22	●	0.23

注Note: ●现货Spot, △交货时间短Short delivery time, O交货时间长Long delivery time.

锁牙式钨钢立铣刀头65°

Indexable Modular Carbide Endmill 65°

圆鼻刀CSM-H系列

Nose Cutter CSM-H Series

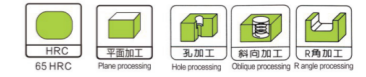
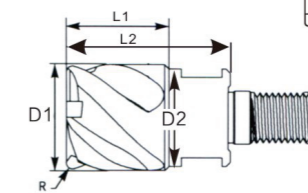

规格型号 Item code	尺寸毫米 Dimensions(mm)						扳手型号 Wrench	备货情况 Inventory	重量 Weight(kg)
	D1	D2	L1	L2	M	R			
CSM-H08-M4-4T-R0.5 65°	8	7.8	15.7	20	M4	0.5	K06	●	0.01
CSM-H10-M5-4T-R0.5 65°	10	9.8	15.7	23	M5	0.5	K08	●	0.02
CSM-H12-M6-4T-R0.5 65°	12	11.7	18.0	25	M6	0.5	K10	●	0.035
CSM-H16-M8-4T-R0.5 65°	16	15.6	22.0	29	M8	0.5	K13	●	0.06
CSM-H20-M10-4T-R0.5 65°	20	19.5	22.0	36	M10	0.5	K17	●	0.12
CSM-H08-M4-4T-R1.0 65°	8	7.8	15.7	20	M4	1.0	K06	●	0.01
CSM-H10-M6-4T-R1.0 65°	10	9.8	15.7	23	M5	1.0	K08	●	0.02
CSM-H12-M6-4T-R1.0 65°	12	11.7	18.0	25	M6	1.0	K10	●	0.035
CSM-H16-M8-4T-R1.0 65°	16	15.6	22.0	29	M8	1.0	K13	●	0.06
CSM-H20-M10-4T-R1.0 65°	20	19.5	22.0	36	M10	1.0	K17	●	0.12

注Note: ●现货Spot, △交货时间短Short delivery time, O交货时间长Long delivery time.

车削系列
Turning Series

铣削系列
Milling Series

搪系列
Fine Broing Series

车削系列
Turning Series

铣削系列
Milling Series

搪系列
Fine Broing Series

锁牙式铣刀头

Indexable Modular Cutter Heads



特色

- 采用优质的钢材淬火处理，提高了刀头的硬度和韧性，使用过程中稳定性更好。
- 采用冷出水孔设计，使每个刀片冷却均匀提高刀片的使用寿命
方便更换，根据加工工件的需要，可更换不同的刀头进行加工。
- 与硬质合金刀杆接合，有效抑制加工时刀头的震动，提高加工工件的表面光洁度，尺寸精度。同时延长刀片的使用寿命
- 定位轴螺纹连接头，保证了与刀杆连接的同轴度，提高了刀杆与刀头的整体性，使刀头更耐用。
- 可以实现高速、高效、长悬深的铣削加工。

Features

- The hardness and toughness of the cutter head are improved by using high quality steel quenching treatment, and the stability is better in the machining process of the cutter head.
- The design of coolant outlet is adopted to make each insert cool evenly and improve the life of insert.
It is convenient to replace according to the need of machining workpiece, different tool heads can be replaced for machining.
- It is connected with the alloy cutter head to effectively restrain the vibration of the cutter head during machining, and improve the surface roughness and dimensional accuracy of the workpiece at the same time extend the life of the insert.
- The fixed shank threaded connector ensures the coaxiality of the connection with the cutter bar, improves the integrity of the cutter bar and the cutter head and makes the cutter head more durable.

锁牙式铣刀头

Modular cutter head

型号说明 Item Code Description

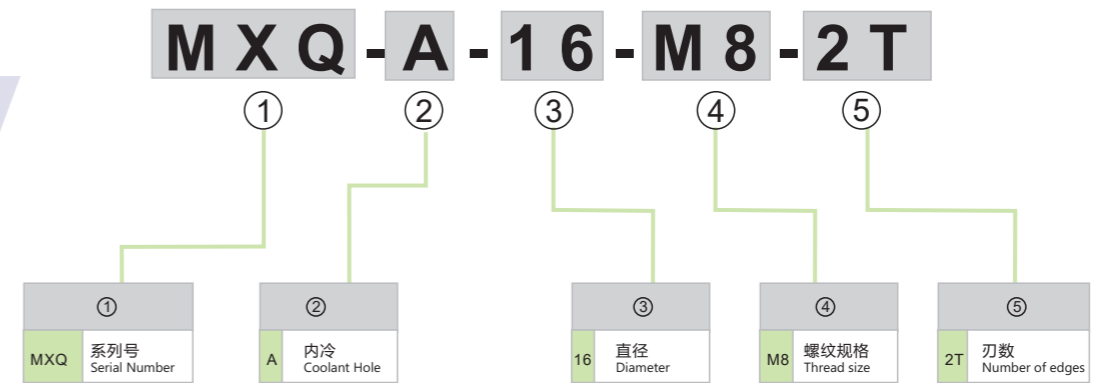

锁牙式铣刀头

Indexable Modular Cutter Heads

车削系列
Turning Series

铣削系列
Milling Series

搪系列
Fine Broing Series

锁牙式铣刀头

Indexable Modular Cutter Heads

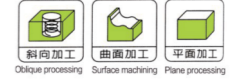

锁牙式铣刀头AJX系列

Modular Cutter Head AJX series

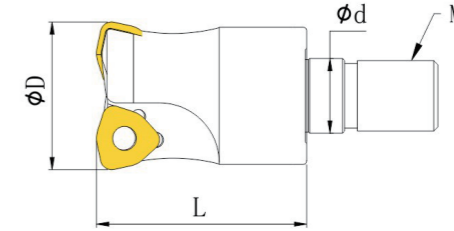

规格型号 Item code		尺寸毫米 Dimensions(mm)				刃数 Teeth	刀片规格 Insert	螺丝 Screw	扳手 Wrench	备货情况 Inventory	重量 Weight(kg)
无出水孔 No OutletHole	出水孔 Outlet Hole	D1	d	L	M						
AJX06-16-M8-2T	AJX06-A-16-M8-2T	16	8.5	25	M8	2	三菱J0...06T215	M2.5*6.0	T8	●	0.04
AJX06-17-M8-2T	AJX06-A-17-M8-2T	17	8.5	25	M8	2	三菱J0...06T215	M2.5*6.0	T8	●	0.04
AJX06-20-M10-3T	AJX06-A-20-M10-3T	20	10.5	30	M10	3	三菱J0...06T215	M2.5*6.0	T8	●	0.06
AJX06-21-M10-3T	AJX06-A-21-M10-3T	21	10.5	30	M10	3	三菱J0...06T215	M2.5*6.0	T8	●	0.06
AJX08-20-M10-2T	AJX08-A-20-M10-2T	20	10.5	30	M10	2	三菱J0...080320	M3.0*7.0	T8	●	0.08
AJX08-21-M10-2T	AJX08-A-21-M10-2T	21	10.5	30	M10	2	三菱J0...080320	M3.0*7.0	T8	●	0.08
AJX08-25-M12-3T	AJX08-A-25-M12-3T	25	12.5	35	M12	3	三菱J0...080320	M3.0*7.0	T8	●	0.12
AJX08-26-M12-3T	AJX08-A-26-M12-3T	26	12.5	35	M12	3	三菱J0...080320	M3.0*7.0	T8	●	0.13
AJX09-32-M16-3T	AJX09-A-32-M16-3T	32	17	40	M16	3	三菱JD...09T320	M3.5*7.0	T15	●	0.15
AJX09-35-M16-3T	AJX09-A-35-M16-3T	35	17	40	M16	3	三菱JD...09T320	M3.5*7.0	T15	●	0.16
AJX12-32-M16-2T	AJX12-A-32-M16-2T	32	17	40	M16	2	三菱JD...120420	M4*10.0	T15	●	0.15
AJX12-35-M16-2T	AJX12-A-35-M16-2T	35	17	40	M16	2	三菱JD...120420	M4*10.0	T15	●	0.16
AJX12-40-M16-3T	AJX12-A-40-M16-3T	40	17	40	M16	3	三菱JD...120420	M4*10.0	T15	●	0.18

注Note: ●现货Spot, △交货时间短Short delivery time, O交货时间长Long delivery time.

车削系列
Turning Series

铣削系列
Milling Series

搪系列
Fine Broing Series

锁牙式铣刀头

Indexable Modular Cutter Heads

锁牙式铣刀头BAP系列

Modular Cutter Head BAP Series

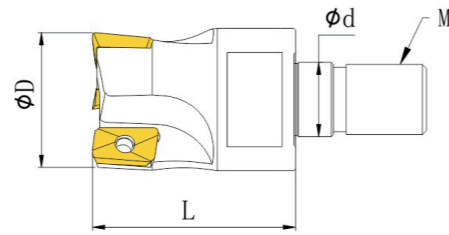

规格型号 Item code		尺寸毫米 Dimensions(mm)				刃数 Teeth	刀片规格 Insert	螺丝 Screw	扳手 Wrench	备货情况 Inventory	重量 Weight(kg)
无出水孔 No OutletHole	出水孔 Outlet Hole	D1	d	L	M						
BAP300R-10-M5-1T	BAP300R-A-10-M5-1T	10	5.5	18	M5	1	三菱 MITSUBISHIAPMT1135	M2.5*6.0	T8	●	0.01
BAP300R-10-M6-1T	BAP300R-A-10-M6-1T	10	6.5	20	M6	1	三菱 MITSUBISHIAPMT1135	M2.5*6.0	T8	●	0.01
BAP300R-11-M5-1T	BAP300R-A-11-M5-1T	11	5.5	18	M5	1	三菱 MITSUBISHIAPMT1135	M2.5*6.0	T8	●	0.01
BAP300R-11-M6-1T	BAP300R-A-11-M6-1T	11	6.5	20	M6	1	三菱 MITSUBISHIAPMT1135	M2.5*6.0	T8	●	0.01
BAP300R-12-M6-1T	BAP300R-A-12-M6-1T	12	6.5	20	M6	1	三菱 MITSUBISHIAPMT1135	M2.5*6.0	T8	●	0.02
BAP300R-13-M6-1T	BAP300R-A-13-M6-1T	13	6.5	20	M6	1	三菱 MITSUBISHIAPMT1135	M2.5*6.0	T8	●	0.02
BAP300R-16-M8-2T	BAP300R-A-16-M8-2T	16	8.5	25	M8	2	三菱 MITSUBISHIAPMT1135	M2.5*6.0	T8	●	0.05
BAP300R-17-M8-2T	BAP300R-A-17-M8-2T	17	8.5	25	M8	2	三菱 MITSUBISHIAPMT1135	M2.5*6.0	T8	●	0.05
BAP300R-20-M10-2T	BAP300R-A-20-M10-2T	20	10.5	30	M10	2	三菱 MITSUBISHIAPMT1135	M2.5*6.0	T8	●	0.07
BAP300R-20-M10-3T	BAP300R-A-20-M10-3T	20	10.5	30	M10	3	三菱 MITSUBISHIAPMT1135	M2.5*6.0	T8	●	0.07
BAP300R-21-M10-2T	BAP300R-A-21-M10-2T	21	10.5	30	M10	2	三菱 MITSUBISHIAPMT1135	M2.5*6.0	T8	●	0.07
BAP300R-21-M10-3T	BAP300R-A-21-M10-3T	21	10.5	30	M10	3	三菱 MITSUBISHIAPMT1135	M2.5*6.0	T8	●	0.07
BAP300R-25-M12-3T	BAP300R-A-25-M12-3T	25	12.5	35	M12	3	三菱 MITSUBISHIAPMT1135	M2.5*6.0	T8	●	0.12
BAP300R-26-M12-2T	BAP300R-A-26-M12-2T	26	12.5	35	M12	2	三菱 MITSUBISHIAPMT1135	M2.5*6.0	T8	●	0.12
BAP300R-26-M12-3T	BAP300R-A-26-M12-3T	26	12.5	35	M12	3	三菱 MITSUBISHIAPMT1135	M2.5*6.0	T8	●	0.12
BAP300R-30-M12-4T	BAP300R-A-30-M12-4T	30	12.5	35	M12	4	三菱 MITSUBISHIAPMT1604	M2.5*6.0	T8	●	0.18
BAP400R-25-M12-2T	BAP400R-A-25-M12-2T	25	12.5	35	M12	2	三菱 MITSUBISHIAPMT1604	M4.0*9.0	T15	●	0.13
BAP400R-26-M12-2T	BAP400R-A-26-M12-2T	26	12.5	35	M12	2	三菱 MITSUBISHIAPMT1604	M4.0*9.0	T15	●	0.14
BAP400R-30-M16-3T	BAP400R-A-30-M16-3T	30	17	35	M16	3	三菱 MITSUBISHIAPMT1604	M4.0*9.0	T15	●	0.20
BAP400R-32-M16-3T	BAP400R-A-32-M16-3T	32	17	40	M16	3	三菱 MITSUBISHIAPMT1604	M4.0*9.0	T15	●	0.25
BAP400R-35-M16-3T	BAP400R-A-35-M16-3T	35	17	40	M16	3	三菱 MITSUBISHIAPMT1604	M4.0*9.0	T15	●	0.30
BAP400R-40-M16-3T	BAP400R-A-40-M16-3T	40	17	40	M16	3	三菱 MITSUBISHIAPMT1604	M4.0*9.0	T15	●	0.35
BAP400R-40-M16-4T	BAP400R-A-40-M16-4T	40	17	40	M16	4	三菱 MITSUBISHIAPMT1604	M4.0*9.0	T15	●	0.35

注Note: ●现货Spot, △交货时间短Short delivery time, O交货时间长Long delivery time.

锁牙式铣刀头

Indexable Modular Cutter Heads

锁牙式铣刀头EMR系列

Modular Cutter Head AJX series

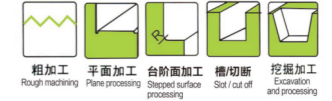
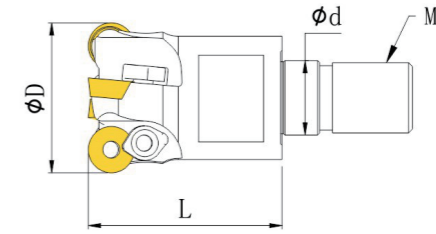

规格型号 Item code		尺寸毫米 Dimensions(mm)				刃数 Teeth	刀片规格 Insert	螺丝 Screw	扳手 Wrench	备货情况 Inventory	重量 Weight(kg)
无出水孔 No OutletHole	出水孔 Outlet Hole	D	d	L	M						
EMR4R-16-M8-2T	EMR4R-A-16-M8-2T	16	8.5	26	M8	2	三菱 MITSUBISHIRPMT08T2MOE	M3.0*7.0	T8	●	0.05
EMR4R-17-M8-2T	EMR4R-A-17-M8-2T	17	8.5	26	M8	2	三菱 MITSUBISHIRPMT08T2MOE	M3.0*7.0	T8	●	0.05
EMR4R-20-M10-2T	EMR4R-A-20-M10-2T	20	10.5	30	M10	2	三菱 MITSUBISHIRPMT08T2MOE	M3.0*7.0	T8	●	0.07
EMR4R-21-M10-2T	EMR4R-A-21-M10-2T	21	10.5	30	M10	2	三菱 MITSUBISHIRPMT08T2MOE	M3.0*7.0	T8	●	0.07
EMR4R-25-M12-3T	EMR4R-A-25-M12-3T	25	12.5	35	M12	3	三菱 MITSUBISHIRPMT08T2MOE	M3.0*7.0	T8	●	0.12
EMR4R-26-M12-3T	EMR4R-A-26-M12-3T	26	12.5	35	M12	3	三菱 MITSUBISHIRPMT08T2MOE	M3.0*7.0	T8	●	0.12
EMR5R-20-M10-2T	EMR5R-A-20-M10-2T	20	10.5	30	M10	2	三菱 MITSUBISHIRPMW1003MOE	M4.0*9.0	T15	●	0.12
EMR5R-21-M10-2T	EMR5R-A-21-M10-2T	21	10.5	30	M10	2	三菱 MITSUBISHIRPMW1003MOE	M4.0*9.0	T15	●	0.12
EMR5R-25-M12-2T	EMR5R-A-25-M12-2T	25	12.5	35	M12	2	三菱 MITSUBISHIRPMW1003MOE	M4.0*9.0	T15	●	0.13
EMR5R-26-M12-2T	EMR5R-A-26-M12-2T	26	12.5	35	M12	2	三菱 MITSUBISHIRPMW1003MOE	M4.0*9.0	T15	●	0.14
EMR5R-30-M12-2T	EMR5R-A-30-M12-2T	30	12.5	35	M12	2	三菱 MITSUBISHIRPMW1003MOE	M4.0*9.0	T15	●	0.20
EMR5R-30-M12-3T	EMR5R-A-30-M12-3T	30	12.5	35	M12	3	三菱 MITSUBISHIRPMW1003MOE	M4.0*9.0	T15	●	0.20
EMR5R-32-M16-3T	EMR5R-A-32-M16-3T	32	17	35	M16	3	三菱 MITSUBISHIRPMW1003MOE	M4.0*9.0	T15	●	0.25
EMR5R-35-M16-3T	EMR5R-A-35-M16-3T	35	17	40	M16	3	三菱 MITSUBISHIRPMW1003MOE	M4.0*9.0	T15	●	0.30
EMR5R-40-M16-3T	EMR5R-A-40-M16-3T	40	17	40	M16	3	三菱 MITSUBISHIRPMW1003MOE	M4.0*9.0	T15	●	0.35
EMR5R-40-M16-4T	EMR5R-A-40-M16-4T	40	17	40	M16	4	三菱 MITSUBISHIRPMW1003MOE	M4.0*9.0	T15	●	0.35
EMR6R-25-M12-2T	EMR6R-A-25-M12-2T	25	12.5	35	M12	2	三菱 MITSUBISHIRPMT1204MOE	M4.0*10.0	T15	●	0.15
EMR6R-26-M12-2T	EMR6R-A-26-M12-2T	26	12.5	35	M12	2	三菱 MITSUBISHIRPMT1204MOE	M4.0*10.0	T15	●	0.15
EMR6R-30-M16-3T	EMR6R-A-30-M16-3T	30	17	35	M16	3	三菱 MITSUBISHIRPMT1204MOE	M4.0*10.0	T15	●	0.20
EMR6R-32-M16-3T	EMR6R-A-32-M16-3T	32	17	35	M16	3	三菱 MITSUBISHIRPMT1204MOE	M4.0*10.0	T15	●	0.25
EMR6R-35-M16-3T	EMR6R-A-35-M16-3T	35	17	40	M16	3	三菱 MITSUBISHIRPMT1204MOE	M4.0*10.0	T15	●	0.30
EMR6R-40-M16-4T	EMR6R-A-40-M16-4T	40	17	40	M16	4	三菱 MITSUBISHIRPMT1204MOE	M4.0*10.0	T15	●	0.35

注Note: ●现货Spot, △交货时间短Short delivery time, O交货时间长Long delivery time.

车削系列
Turning Series

铣削系列
Milling Series

搪系列
Fine Broing Series

车削系列
Turning Series

铣削系列
Milling Series

搪系列
Fine Broing Series

锁牙式铣刀头

Indexable Modular Cutter Heads

锁牙式铣刀头ASMO7R系列

Modular Cutter Head ASMO7R series

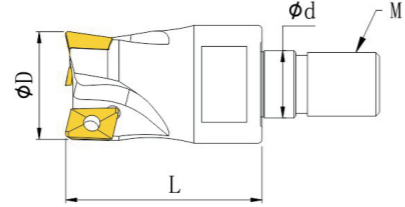
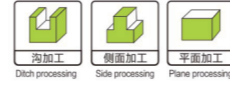

规格型号 Item code		尺寸毫米 Dimensions(mm)				刃数 Teeth	刀片规格 Insert	螺丝 Screw	扳手 Wrench	备货情况 Inventory	重量 Weight(kg)
无出水孔 No OutletHole	出水孔 Outlet Hole	D	d	L	M						
ASM07R-08-M4-1T	ASM07R-A-08-M4-1T	8	4.5	15	M4	1	日立 Hitachi JDMT070208REDMT07020R	M1.8*4.0	T6	●	0.02
ASM07R-09-M4-1T	ASM07R-A-09-M4-1T	9	4.5	15	M4	1	日立Hitachi JDMT070208REDMT07020R	M1.8*4.0	T6	●	0.02
ASM07R-10-M5-2T	ASM07R-A-10-M5-2T	10	5.5	18	M5	2	日立 Hitachi JDMT070208REDMT07020R	M1.8*4.0	T6	●	0.02
ASM07R-10-M6-2T	ASM07R-A-10-M6-2T	10	6.5	20	M6	2	日立Hitachi JDMT070208REDMT07020R	M1.8*4.0	T6	●	0.02
ASM07R-11-M5-2T	ASM07R-A-11-M5-2T	11	5.5	18	M5	2	日立 Hitachi JDMT070208REDMT07020R	M1.8*4.0	T6	●	0.03
ASM07R-11-M6-2T	ASM07R-A-11-M6-2T	11	6.5	20	M6	2	日立Hitachi JDMT070208REDMT07020R	M1.8*4.0	T6	●	0.03
ASM07R-12-M6-2T	ASM07R-A-12-M6-2T	12	6.5	20	M6	2	日立Hitachi JDMT070208REDMT07020R	M1.8*4.0	T6	●	0.03
ASM07R-12-M6-3T	ASM07R-A-12-M6-3T	12	6.5	20	M6	3	日立 Hitachi JDMT070208REDMT07020R	M1.8*4.0	T6	●	0.03
ASM07R-13-M6-2T	ASM07R-A-13-M6-2T	13	6.5	20	M6	2	日立 Hitachi JDMT070208REDMT07020R	M1.8*4.0	T6	●	0.03
ASM07R-16-M8-3T	ASM07R-A-16-M8-3T	16	8.5	26	M8	3	日立Hitachi JDMT070208REDMT07020R	M1.8*4.0	T6	●	0.05
ASM07R-17-M8-3T	ASM07R-A-17-M8-3T	17	8.5	26	M8	3	日立 Hitachi JDMT070208REDMT07020R	M1.8*4.0	T6	●	0.05
ASM07R-21-M10-4T	ASM07R-A-21-M10-4T	21	10.5	30	M10	4	日立Hitachi JDMT070208REDMT07020R	M1.8*4.0	T66	●	0.08

注Note: ●现货Spot, △交货时间短Short delivery time, O交货时间长Long delivery time.

锁牙式铣刀头ASMO7R系列

Modular Cutter Head ASMO7R series

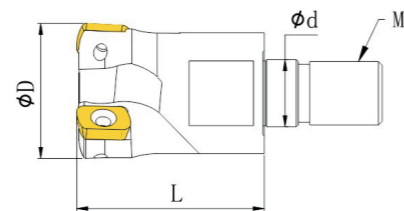
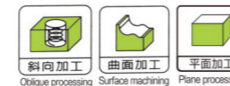

规格型号 Item code		尺寸毫米 Dimensions(mm)				刃数 Teeth	刀片规格 Insert	螺丝 Screw	扳手 Wrench	备货情况 Inventory	重量 Weight(kg)
无出水孔 No OutletHole	出水孔 Outlet Hole	D	d	L	M						
ASR20R-16-M8-2T	ASR20R-A-16-M8-2T	16	8.5	26	M8	2	日立 Hitachi EPNW0603TN-8	M2.5*6.0	T8	●	0.04
ASR20R-17-M8-2T	ASR20R-A-17-M8-2T	17	8.5	26	M8	2	日立Hitachi EPNW0603TN-8	M2.5*6.0	T8	●	0.04
ASR20R-20-M10-3T	ASR20R-A-20-M10-3T	20	10.5	30	M10	3	日立 Hitachi EPNW0603TN-8	M2.5*6.0	T8	●	0.07
ASR20R-21-M10-2T	ASR20R-A-21-M10-2T	21	10.5	30	M10	2	日立Hitachi EPNW0603TN-8	M2.5*6.0	T8	●	0.08
ASR20R-21-M10-3T	ASR20R-A-21-M10-3T	21	10.5	30	M10	3	日立 Hitachi EPNW0603TN-8	M2.5*6.0	T8	●	0.08
ASR20R-25-M12-3T	ASR20R-A-25-M12-3T	25	12.5	35	M12	3	日立Hitachi EPNW0603TN-8	M2.5*6.0	T8	●	0.14
ASR20R-26-M12-3T	ASR20R-A-26-M12-3T	26	12.5	35	M12	3	日立 Hitachi EPNW0603TN-8	M2.5*6.0	T8	●	0.16
ASR20R-32-M16-4T	ASR20R-A-32-M16-4T	32	17	35	M16	4	日立Hitachi EPNW0603TN-8	M2.5*6.0	T8	●	0.25

注Note: ●现货Spot, △交货时间短Short delivery time, O交货时间长Long delivery time.

锁牙式铣刀头

Indexable Modular Cutter Heads

锁牙式铣刀头AJC系列

Modular Cutter Head AJC series

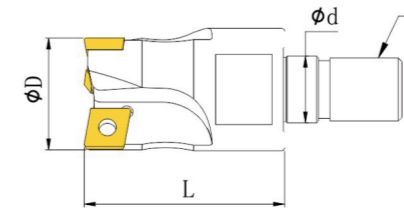
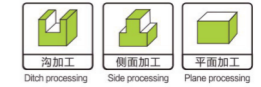

规格型号 Item code		尺寸毫米 Dimensions(mm)				刃数 Teeth	刀片规格 Insert	螺丝 Screw	扳手 Wrench	备货情况 Inventory	重量 Weight(kg)
无出水孔 No OutletHole	出水孔 Outlet Hole	D	d	L	M						
AJC-16-M8-2T	AJC-A-16-M8-2T	16	8.5	26	M8	2	日立HitachiCCMT060204	M2.5*6.0	T9	●	0.04
AJC-17-M8-3T	AJC-A-17-M8-3T	17	8.5	26	M8	3	日立HitachiCCMT060204	M2.5*6.0	T9	●	0.05
AJC-20-M10-3T	AJC-A-20-M10-3T	20	10.5	30	M10	3	日立HitachiCCMT060204	M2.5*6.0	T9	●	0.08
AJC-21-M10-4T	AJC-A-21-M10-4T	21	10.5	30	M10	4	日立HitachiCCMT060204	M2.5*6.0	T9	●	0.07
AJC-25-M12-4T	AJC-A-25-M12-4T	25	12.5	35	M12	4	日立HitachiCCMT060204	M2.5*6.0	T9	●	0.13
AJC-26-M12-5T	AJC-A-26-M12-5T	26	12.5	35	M12	5	日立HitachiCCMT060204	M2.5*6.0	T9	●	0.15

注Note: ●现货Spot, △交货时间短Short delivery time, O交货时间长Long delivery time.

锁牙式铣刀头ASPV系列

Modular Cutter Head AJC series

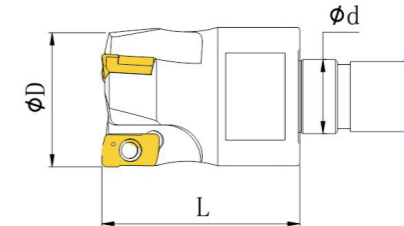
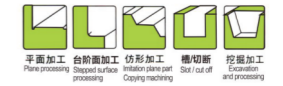

规格型号 Item code		尺寸毫米 Dimensions(mm)				刃数 Teeth	刀片规格 Insert	螺丝 Screw	扳手 Wrench	备货情况 Inventory	重量 Weight(kg)
无出水孔 No OutletHole	出水孔 Outlet Hole	D	d	L	M						
ASPV-16-M8-2T	ASPV-A-16-M8-2T	16	8.5	26	M8	2	日立HitachiMPHW0603TN	M2.5*6.0	T8	●	0.04
ASPV-17-M8-2T	ASPV-A-17-M8-2T	17	8.5	26	M8	2	日立HitachiMPHW0603TN	M2.5*6.0	T8	●	0.05
ASPV-20-M10-2T	ASPV-A-20-M10-2T	20	10.5	30	M10	2	日立HitachiMPHW0603TN	M2.5*6.0	T8	●	0.08
ASPV-20-M10-3T	ASPV-A-20-M10-3T	20	10.5	30	M10	3	日立HitachiMPHW0603TN	M2.5*6.0	T8	●	0.08
ASPV-21-M10-2T	ASPV-A-21-M10-2T	21	10.5	30	M10	2	日立HitachiMPHW0603TN	M2.5*6.0	T8	●	0.10
ASPV-21-M10-3T	ASPV-A-21-M10-3T	21	10.5	30	M10	3	日立HitachiMPHW0603TN	M2.5*6.0	T8	●	0.10
ASPV-25-M12-3T	ASPV-A-25-M12-3T	25	12.5	35	M12	3	日立HitachiMPHW0603TN	M2.5*6.0	T8	●	0.13
ASPV-25-M12-4T	ASPV-A-25-M12-4T	25	12.5	35	M12	4	日立HitachiMPHW0603TN	M2.5*6.0	T8	●	0.13
ASPV-26-M12-3T	ASPV-A-26-M12-3T	26	12.5	35	M12	3	日立HitachiMPHW0603TN	M2.5*6.0	T8	●	0.15
ASPV-26-M12-4T	ASPV-A-26-M12-4T	26	12.5	35	M12	4	日立HitachiMPHW0603TN	M2.5*6.0	T8	●	0.15
ASPV-32-M16-4T	ASPV-A-32-M16-4T	32	17	40	M16	4	日立HitachiMPHW0603TN	M2.5*6.0	T8	●	0.20

注Note: ●现货Spot, △交货时间短Short delivery time, O交货时间长Long delivery time.

车削系列
Turning Series

铣削系列
Milling Series

搪系列
Fine Broing Series

车削系列
Turning Series

铣削系列
Milling Series

搪系列
Fine Broing Series

锁牙式铣刀头

Indexable Modular Cutter Heads

锁牙式铣刀头AHU系列

Modular Cutter Head ASMO7R series

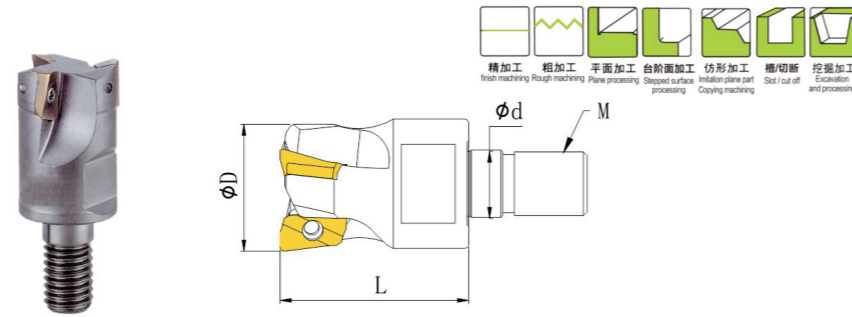

规格型号 Item code		尺寸毫米 Dimensions(mm)				刃数 Teeth	刀片规格 Insert	螺丝 Screw	扳手 Wrench	备货情况 Inventory	重量 Weight(kg)
无出水孔 No OutletHole	出水孔 Outlet Hole	D	d	L	M						
AHU10-16-M8-2T	AHU10-A-16-M8-2T	16	8.5	26	M8	2	日立HitachiJDMT1003	M2.5*6.0	T8	●	0.05
AHU10-17-M8-2T	AHU10-A-17-M8-2T	17	8.5	26	M8	2	日立HitachiJDMT1003	M2.5*6.0	T8	●	0.05
AHU10-20-M10-2T	AHU10-A-20-M10-2T	20	10.5	30	M10	2	日立HitachiJDMT1003	M2.5*6.0	T8	●	0.07
AHU10-20-M10-3T	AHU10-A-20-M10-3T	20	10.5	30	M10	3	日立HitachiJDMT1003	M2.5*6.0	T8	●	0.07
AHU10-21-M10-2T	AHU10-A-21-M10-2T	21	10.5	35	M10	2	日立HitachiJDMT1003	M2.5*6.0	T8	●	0.07
AHU10-21-M10-3T	AHU10-A-21-M10-3T	21	10.5	35	M10	3	日立HitachiJDMT1003	M2.5*6.0	T8	●	0.12
AHU10-25-M12-3T	AHU10-A-25-M12-3T	25	12.5	35	M12	3	日立HitachiJDMT1003	M2.5*6.0	T8	●	0.12
AHU10-25-M12-4T	AHU10-A-25-M12-4T	25	12.5	35	M12	4	日立HitachiJDMT1003	M2.5*6.0	T8	●	0.12
AHU10-26-M12-3T	AHU10-A-26-M12-3T	26	12.5	35	M12	3	日立HitachiJDMT1003	M2.5*6.0	T8	●	0.12
AHU10-26-M12-4T	AHU10-A-26-M12-4T	26	12.5	35	M12	4	日立HitachiJDMT1003	M2.5*6.0	T8	●	0.12
AHU15-25-M12-2T	AHU15-A-25-M12-2T	25	12.5	35	M12	2	日立HitachiJDMT1505	M4.0*10	T15	●	0.12
AHU15-26-M12-2T	AHU15-A-26-M12-2T	26	12.5	35	M12	2	日立HitachiJDMT1505	M4.0*10	T15	●	0.12
AHU15-32-M16-3T	AHU15-A-32-M16-3T	32	17	40	M16	3	日立HitachiJDMT1505	M4.0*10	T15	●	0.20
AHU15-35-M16-3T	AHU15-A-35-M16-3T	35	17	40	M16	3	日立HitachiJDMT1505	M4.0*10	T15	●	0.25

注Note: ●现货Spot, △交货时间短Short delivery time, O交货时间长Long delivery time.

锁牙式铣刀头ABPF系列

Modular Cutter Head ABPF series

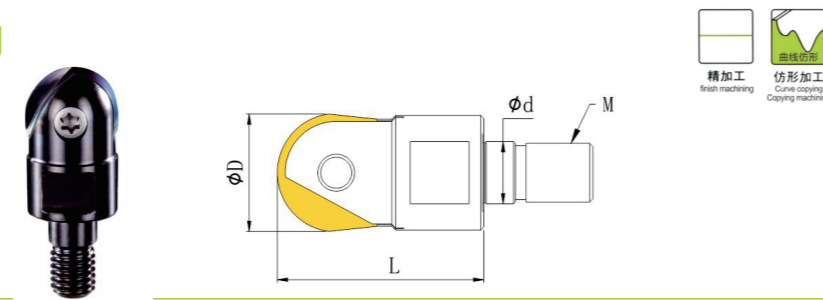

规格型号 Item code		尺寸毫米 Dimensions(mm)				刃数 Teeth	刀片规格 Insert	螺丝 Screw	扳手 Wrench	备货情况 Inventory	重量 Weight(kg)
无出水孔 No OutletHole	出水孔 Outlet Hole	D	d	L	M						
ABPF-R5-M5-1T	ABPF-A-R5-M5-1T	10	5.5	18	M5	1	日立HitachiZPFG100-GZDFG100-W M3.5*8.1	T15	●	0.15	
ABPF-R6-M6-1T	ABPF-A-R6-M6-1T	12	6.5	20	M6	1	日立HitachiZPFG120-GZDFG120-W M5*9.8	T20	●	0.15	
ABPF-R8-M8-1T	ABPF-A-R8-M8-1T	16	8.5	26	M8	1	日立HitachiZPFG160-GZDFG160-W M5*13.5	T20	●	0.2	
ABPF-R10-M10-1T	ABPF-A-R10-M10-1T	20	10.5	30	M10	1	日立HitachiZPFG200-GZDFG200-W M6*16.7	T20	●	0.25	
ABPF-R12.5-M12-1T	ABPF-A-R12.5-M12-1T	25	12.5	35	M12	1	日立HitachiZPFG250-GZDFG250-W M6*21.8	T20	●	0.25	
ABPF-R15-M16-1T	ABPF-A-R15-M16-1T	30	17	40	M16	1	日立HitachiZPFG300-GZDFG300-W M8*25	T30	●	0.3	

注Note: ●现货Spot, △交货时间短Short delivery time, O交货时间长Long delivery time.

锁牙式铣刀头

Indexable Modular Cutter Heads

锁牙式铣刀头SS4P系列

Modular Cutter Head SS4P series

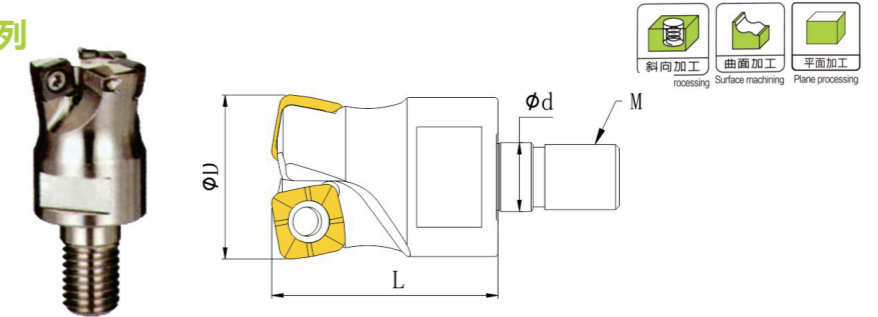

规格型号 Item code		尺寸毫米 Dimensions(mm)				刃数 Teeth	刀片规格 Insert	螺丝 Screw	扳手 Wrench	备货情况 Inventory	重量 Weight(kg)
无出水孔 No OutletHole	出水孔 Outlet Hole	D	d	L	M						
SS4P-20-M10-2T	SS4P-A-20-M10-2T	20	10.5	30	M10	2	日立HitachiSP**07T2	M3.0*6.0	T10	●	0.07
SS4P-20-M10-3T	SS4P-A-20-M10-3T	20	10.5	30	M10	3	日立HitachiSP**07T2	M3.0*6.0	T10	●	0.07
SS4P-25-M12-3T	SS4P-A-25-M12-3T	25	12.5	35	M12	3	日立HitachiSP**07T2	M3.0*6.0	T10	●	0.13
SS4P-25-M12-4T	SS4P-A-25-M12-4T	25	12.5	35	M12	4	日立HitachiSP**07T2	M3.0*6.0	T10	●	0.13
SS4P-32-M16-4T	SS4P-A-32-M16-4T	32	17	40	M16	4	日立HitachiSP**07T2	M3.0*6.0	T10	●	0.27
SS4P-32-M16-5T	SS4P-A-32-M16-5T	32	17	40	M16	5	日立HitachiSP**07T2	M3.0*6.0	T10	●	0.27
SS4P-35-M16-4T	SS4P-A-35-M16-4T	35	17	40	M16	4	日立HitachiSP**07T2	M3.0*6.0	T10	●	0.35
SS4P-35-M16-5T	SS4P-A-35-M16-5T	35	17	40	M16	5	日立HitachiSP**07T2	M3.0*6.0	T10	●	0.35

注Note: ●现货Spot, △交货时间短Short delivery time, O交货时间长Long delivery time.

车削系列
Turning Series

铣削系列
Milling Series

搪系列
Fine Broing Series

车削系列
Turning Series

铣削系列
Milling Series

搪系列
Fine Broing Series

锁牙式铣刀头

Indexable Modular Cutter Heads

锁牙式铣刀头TRS系列

Modular Cutter Head TRS series

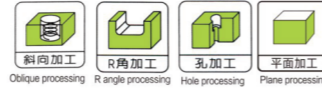
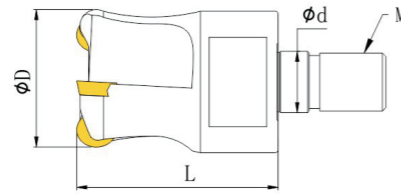

规格型号 Item code		尺寸毫米 Dimensions(mm)				刃数 Teeth	刀片规格 Insert	螺丝 Screw	扳手 Wrench	备货情况 Inventory	重量 Weight(kg)
无出水孔 No OutletHole	出水孔 Outlet Hole	D	d	L	M						
TRS2.5R-10-M5-2T	TRS2.5R-A-10-M5-2T	10	5.5	18	M5	2	日立HitachiRD**0501**	M1.8*4.0	T6	●	0.01
TRS2.5R-11-M5-2T	TRS2.5R-A-11-M5-2T	11	5.5	18	M5	2	日立HitachiRD**0501**	M1.8*4.0	T6	●	0.01
TRS2.5R-12-M6-2T	TRS2.5R-A-12-M6-2T	12	6.5	20	M6	2	日立HitachiRD**0501**	M1.8*4.0	T6	●	0.02
TRS2.5R-12-M6-3T	TRS2.5R-A-12-M6-3T	12	6.5	20	M6	3	日立HitachiRD**0501**	M1.8*4.0	T6	●	0.01
TRS2.5R-13-M6-2T	TRS2.5R-A-13-M6-2T	13	6.5	20	M6	2	日立HitachiRD**0501**	M1.8*4.0	T6	●	0.02
TRS2.5R-13-M6-3T	TRS2.5R-A-13-M6-3T	13	6.5	20	M6	3	日立HitachiRD**0501**	M1.8*4.0	T6	●	0.02
TRS2.5R-16-M8-3T	TRS2.5R-A-16-M8-3T	16	8.5	26	M8	3	日立HitachiRD**0501**	M1.8*4.0	T6	●	0.03
TRS2.5R-17-M8-4T	TRS2.5R-A-17-M8-4T	17	8.5	26	M8	4	日立HitachiRD**0501**	M1.8*4.0	T6	●	0.04
TRS3R-12-M6-2T	TRS3R-A-12-M6-2T	12	6.5	20	M6	2	日立HitachiRD**0602*	M2.0*4.0	T6	○	0.02
TRS3R-13-M6-2T	TRS3R-A-13-M6-2T	13	6.5	20	M6	2	日立HitachiRD**0602*	M2.0*4.0	T6	○	0.02
TRS3R-16-M8-3T	TRS3R-A-16-M8-3T	16	8.5	26	M8	3	日立HitachiRD**0602**	M2.0*4.0	T6	○	0.04
TRS3R-17-M8-3T	TRS3R-A-17-M8-3T	17	8.5	26	M8	3	日立HitachiRD**0602*	M2.0*4.0	T6	○	0.05
TRS3R-20-M10-4T	TRS3R-A-20-M10-4T	20	10.5	30	M10	4	日立HitachiRD**0602**	M2.0*4.0	T6	○	0.06
TRS3R-21-M10-4T	TRS3R-A-21-M10-4T	21	10.5	30	M10	4	日立HitachiRD**0602*	M2.0*4.0	T6	○	0.06
TRS3R-25-M12-4T	TRS3R-A-25-M12-4T	25	12.5	35	M12	4	日立HitachiRD**0602**	M2.0*4.0	T6	○	0.08
TRS3R-26-M12-4T	TRS3R-A-26-M12-4T	26	12.5	35	M12	4	日立HitachiRD**0602*	M2.0*4.0	T6	○	0.08
TRS3R-30-M16-5T	TRS3R-A-30-M16-5T	30	17	40	M16	5	日立HitachiRD**0602**	M2.0*4.0	T6	○	0.10
TRS3R-32-M16-5T	TRS3R-A-32-M16-5T	32	17	40	M16	5	日立HitachiRD**0702**	M2.0*4.0	T6	○	0.10
TRS3.5R-12-M6-2T	TRS3.5R-A-12-M6-2T	12	6.5	20	M6	2	日立HitachiRD**0702**	M2.5*6.0	T8	●	0.02
TRS3.5R-13-M6-2T	TRS3.5R-A-13-M6-2T	13	6.5	20	M6	2	日立HitachiRD**0702**	M2.5*6.0	T8	●	0.02
TRS3.5R-16-M8-2T	TRS3.5R-A-16-M8-2T	16	8.5	26	M8	2	日立HitachiRD**0702**	M2.5*6.0	T8	●	0.04
TRS3.5R-17-M8-2T	TRS3.5R-A-17-M8-2T	17	8.5	26	M8	2	日立HitachiRD**0702**	M2.5*6.0	T8	●	0.04
TRS3.5R-20-M10-3T	TRS3.5R-A-20-M10-3T	20	10.5	30	M10	3	日立HitachiRD**0702**	M2.5*6.0	T8	●	0.06
TRS3.5R-21-M10-2T	TRS3.5R-A-21-M10-2T	21	10.5	30	M10	2	日立HitachiRD**0702**	M2.5*6.0	T8	●	0.06
TRS3.5R-21-M10-3T	TRS3.5R-A-21-M10-3T	21	10.5	30	M10	3	日立HitachiRD**0702**	M2.5*6.0	T8	●	0.06
TRS3.5R-25-M12-4T	TRS3.5R-A-25-M12-4T	25	12.5	35	M12	4	日立HitachiRD**0702**	M2.5*6.0	T8	●	0.08
TRS3.5R-26-M12-4T	TRS3.5R-A-26-M12-4T	26	12.5	35	M12	4	日立HitachiRD**0702**	M2.5*6.0	T8	●	0.08

注Note: ●现货Spot, △交货时间短Short delivery time, ○交货时间长Long delivery time.

车削系列
Turning Series

铣削系列
Milling Series

搪系列
Fine Broing Series

锁牙式铣刀头

Indexable Modular Cutter Heads

锁牙式铣刀头TRS系列

Modular Cutter Head SS4P series

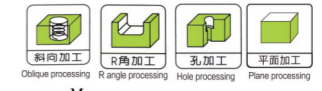
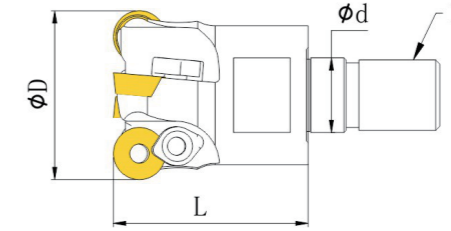

规格型号 Item code		尺寸毫米 Dimensions(mm)				刃数 Teeth	刀片规格 Insert	压板 Platen	螺丝 Screw	扳手 Wrench	备货情况 Inventory	重量 Weight(kg)
无出水孔 No OutletHole	出水孔 Outlet Hole	D	d	L	M							
TRS4R-16-M8-2T	TRS4R-A-16-M8-2T	16	8.5	26	M8	2	*日立HitachiRDMT0802*	R4 HC	M3.0*7.0	T8	●	0.06
TRS4R-17-M8-2T	TRS4R-A-17-M8-2T	17	8.5	26	M8	2	*日立HitachiRDMT0802*	R4 HC	M3.0*7.0	T8	●	0.08
TRS4R-20-M10-2T	TRS4R-A-20-M10-2T	20	10.5	30	M10	2	*日立HitachiRDMT0802*	R4 HC	M3.0*7.0	T8	●	0.08
TRS4R-21-M10-2T	TRS4R-A-21-M10-2T	21	10.5	30	M10	2	*日立HitachiRDMT0802*	R4 HC	M3.0*7.0	T8	●	0.10
TRS4R-25-M12-3T	TRS4R-A-25-M12-3T	25	12.5	35	M12	3	*日立HitachiRDMT0802*	R4 HC	M3.0*7.0	T8	●	0.10
TRS4R-26-M12-3T	TRS4R-A-26-M12-3T	26	12.5	35	M12	3	*日立HitachiRDMT0802*	R4 HC	M3.0*7.0	T8	●	0.10
TRS5R-20-M10-2T	TRS5R-A-20-M10-2T	20	10.5	30	M10	2	*日立HitachiRDMT10T3*	R5 HC	M4.0*9.0	T15	●	0.10
TRS5R-21-M10-2T	TRS5R-A-21-M10-2T	21	10.5	30	M10	2	*日立HitachiRDMT10T3*	R5 HC	M4.0*9.0	T15	●	0.13
TRS5R-25-M12-2T	TRS5R-A-25-M12-2T	25	12.5	35	M12	2	*日立HitachiRDMT10T3*	R5 HC	M4.0*9.0	T15	●	0.13
TRS5R-25-M12-3T	TRS5R-A-25-M12-3T	25	12.5	35	M12	3	*日立HitachiRDMT10T3*	R5 HC	M4.0*9.0	T15	●	0.18
TRS5R-26-M12-2T	TRS5R-A-26-M12-2T	26	12.5	35	M12	2	*日立HitachiRDMT10T3*	R5 HC	M4.0*9.0	T15	●	0.20
TRS5R-30-M12-2T	TRS5R-A-30-M12-2T	30	12.5	35	M12	2	*日立HitachiRDMT10T3*	R5 HC	M4.0*9.0	T15	●	0.25
TRS5R-32-M16-3T	TRS5R-A-32-M16-3T	32	17	35	M16	3	*日立HitachiRDMT10T3*	R5 HC	M4.0*9.0	T15	●	0.30
TRS5R-35-M16-3T	TRS5R-A-35-M16-3T	35	17	40	M16	3	*日立HitachiRDMT10T3*	R5 HC	M4.0*9.0	T15	●	0.35
TRS5R-40-M16-3T	TRS5R-A-40-M16-3T	40	17	40	M16	3	*日立HitachiRDMT10T3*	R5 HC	M4.0*9.0	T15	●	0.35
TRS5R-40-M16-4T	TRS5R-A-40-M16-4T	40	17	40	M16	4	*日立HitachiRDMT1204*	R5 HC	M4.0*9.0	T15	●	0.13
TRS6R-25-M12-2T	TRS6R-A-25-M12-2T	25	12.5	35	M12	2	*日立HitachiRDMT1204*	R6 HC	M4.0*10.0	T15	●	0.18
TRS6R-26-M12-2T	TRS6R-A-26-M12-2T	26	12.5	35	M12	2	*日立HitachiRDMT1204*	R6 HC	M4.0*10.0	T15	●	0.35
TRS6R-30-M16-3T	TRS6R-A-30-M16-3T	30	17	35	M16	3	*日立HitachiRDMT1204*	R6 HC	M4.0*10.0	T15	●	0.38
TRS6R-32-M16-2T	TRS6R-A-32-M16-3T	32	17	35	M16	2	*日立HitachiRDMT1204*	R6 HC	M4.0*10.0	T15	●	0.42
TRS6R-35-M16-3T	TRS6R-A-35-M16-3T	35	17	40	M16	3	*日立HitachiRDMT1204*	R6 HC	M4.0*10.0	T15	●	0.45
TRS6R-40-M16-4T	TRS6R-A-40-M16-4T	40	17	40	M16	4	*日立HitachiRDMT1204*	R6 HC	M4.0*10.0	T15	●	0.45

注Note: ●现货Spot, △交货时间短Short delivery time, ○交货时间长Long delivery time.

车削系列
Turning Series

铣削系列
Milling Series

搪系列
Fine Broing Series

锁牙式铣刀头

Indexable Modular Cutter Heads

锁牙式铣刀头T2139系列

Modular Cutter Head TRS series

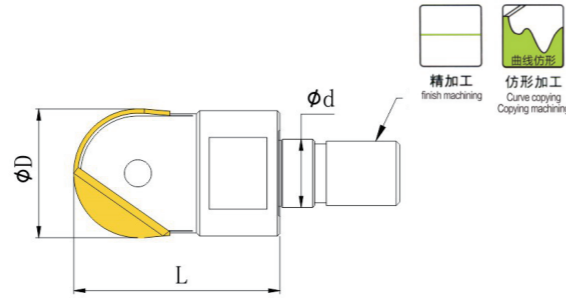

规格型号 Item code		尺寸毫米 Dimensions(mm)				刃数 Teeth	刀片规格 Insert	螺丝 Screw	扳手 Wrench	备货情况 Inventory
无出水孔 No OutletHole	出水孔 Outlet Hole	D	d	L	M					
T2139-R5-M5-1T	T2139-A-R5-M5-1T	10	5.5	20	M5	1	瓦尔特, 黛杰P3200-D10	M4*9.0	T15	●
T2139-R6-M6-1T	T2139-A-R6-M6-1T	12	6.5	20	M6	1	瓦尔特, 黛杰P3200-D12	M5*9.0	T20	●
T2139-R8-M8-1T	T2139-A-R8-M8-1T	16	8.5	28	M8	1	瓦尔特, 黛杰P3200-D16	M5*13.0	T20	●
T2139-R10-M10-1T	T2139-A-R10-M10-1T	20	10.5	30	M10	1	瓦尔特, 黛杰P3200-D20	M5*16.0	T20	●
T2139-R12.5-M12-1T	T2139-A-R12.5-M12-1T	25	12.5	35	M12	1	瓦尔特, 黛杰P3200-D25	M6*21.0	T20	●
T2139-R15-M16-1T	T2139-A-R15-M16-1T	30	17	40	M16	1	瓦尔特, 黛杰P3200-D30	M8*25.0	T30	●

注Note: ●现货Spot, △交货时间短Short delivery time, O交货时间长Long delivery time.

锁牙式铣刀头UEX系列

Modular Cutter Head UEXA series

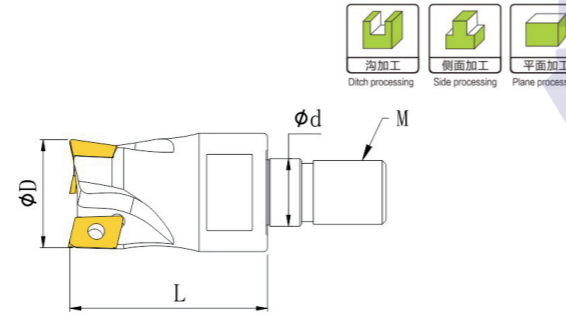

规格型号 Item code		尺寸毫米 Dimensions(mm)				刃数 Teeth	刀片规格 Insert	螺丝 Screw	扳手 Wrench	备货情况 Inventory	重量 Weight(kg)
无出水孔 No OutletHole	出水孔 Outlet Hole	D	d	L	M						
UEX-16-M8-1T	UEX-A-16-M8-1T	16	8.5	26	M8	1	日立 Hitachi APET120204	M3.5*7.0	T15	●	0.04
UEX-17-M8-1T	UEX-A-17-M8-1T	17	8.5	26	M8	1	日立 Hitachi APET120204	M3.5*7.0	T15	●	0.05
UEX-17-M8-2T	UEX-A-17-M8-2T	17	8.5	26	M8	2	日立 Hitachi APET120204	M3.5*7.0	T15	●	0.05
UEX-20-M10-2T	UEX-A-20-M10-2T	20	10.5	30	M10	2	日立 Hitachi APET120204	M3.5*7.0	T15	●	0.06
UEX-21-M10-2T	UEX-A-21-M10-2T	21	10.5	30	M10	2	日立 Hitachi APET120204	M3.5*7.0	T15	●	0.07
UEX-25-M12-3T	UEX-A-25-M12-3T	25	12.5	35	M12	3	日立 Hitachi APET120204	M3.5*7.0	T15	●	0.12
UEX-26-M12-3T	UEX-A-26-M12-3T	26	12.5	35	M12	3	日立 Hitachi APET120204	M3.5*7.0	T15	●	0.12
UEX-32-M16-4T	UEX-A-32-M16-4T	32	17	43	M16	4	日立 Hitachi APET120204	M3.5*7.0	T15	●	0.24
UEX-35-M16-4T	UEX-A-35-M16-4T	35	17	43	M16	4	日立 Hitachi APET120204	M3.5*7.0	T15	●	0.25

注Note: ●现货Spot, △交货时间短Short delivery time, O交货时间长Long delivery time.

锁牙式铣刀头

Indexable Modular Cutter Heads

锁牙式铣刀头MXG系列

Modular Cutter Head MXG series

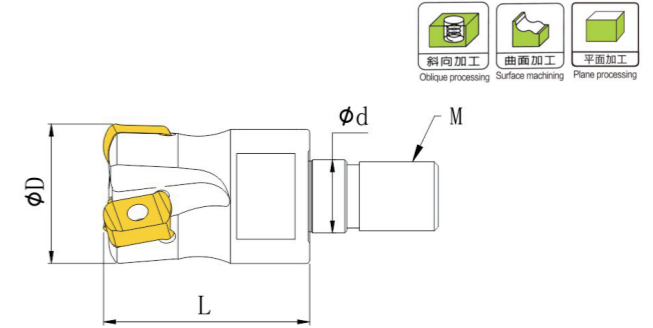

规格型号 Item code		尺寸毫米 Dimensions(mm)				刃数 Teeth	刀片规格 Insert	螺丝 Screw	扳手 Wrench	备货情况 Inventory	重量 Weight(kg)
无出水孔 No OutletHole	出水孔 Outlet Hole	D	d	L	M						
MXG-16-M8-2T	MXG-A-16-M8-2T	16	8.5	26	M8	2	ENMU100412ZER-SL黛杰	M2.5*6	T8	●	0.06
MXG-17-M8-2T	MXG-A-17-M8-2T	17	8.5	26	M8	2	ENMU100412ZER-SL黛杰	M2.5*7	T8	●	0.06
MXG-20-M10-3T	MXG-A-20-M10-3T	20	10.5	30	M10	3	ENMU100412ZER-SL黛杰	M2.5*7	T8	●	0.06
MXG-21-M10-3T	MXG-A-21-M10-3T	21	10.5	30	M10	3	ENMU100412ZER-SL黛杰	M2.5*7	T8	●	0.06
MXG-25-M12-3T	MXG-A-25-M12-3T	25	12.5	35	M12	3	ENMU100412ZER-SL黛杰	M2.5*7	T8	●	0.06
MXG-25-M12-4T	MXG-A-25-M12-4T	25	12.5	35	M12	4	ENMU100412ZER-SL黛杰	M2.5*7	T8	●	0.06
MXG-26-M12-4T	MXG-A-26-M12-4T	26	12.5	35	M12	4	ENMU100412ZER-SL黛杰	M2.5*7	T8	●	0.06
MXG-40-M16-6T	MXG-A-40-M16-6T	40	17	40	M16	6	ENMU100412ZER-SL黛杰	M2.5*7	T8	●	0.15

注Note: ●现货Spot, △交货时间短Short delivery time, O交货时间长Long delivery time.

锁牙式铣刀头MSH系列

Modular Cutter Head MSH series

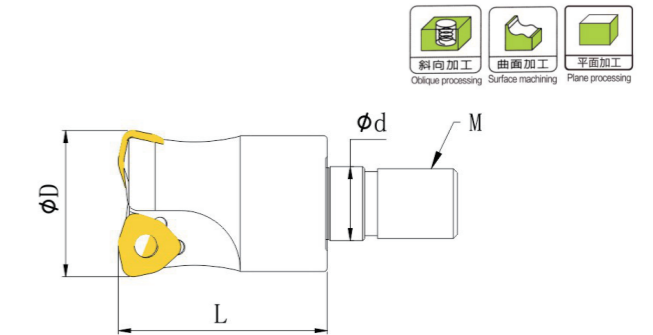

规格型号 Item code		尺寸毫米 Dimensions(mm)				刃数 Teeth	刀片规格 Insert	螺丝 Screw	扳手 Wrench	备货情况 Inventory	重量 Weight(kg)
无出水孔 No OutletHole	出水孔 Outlet Hole	D	d	L	M						
MSH04-16-M8-2T	MSH04-A-16-M8-2T	16	8.5	26	M8	2	黛杰DUJETWVO**04**	M2.5*6	T8	●	0.04
MSH04-17-M8-2T	MSH04-A-17-M8-2T	17	8.5	26	M8	2	黛杰DUJETWVO**04**	M2.5*6	T8	●	0.04
MSH05-20-M10-2T	MSH05-A-20-M10-2T	20	10.5	30	M10	2	黛杰DUJETWVO**05**	M3*6	T10	●	0.08
MSH05-21-M10-2T	MSH05-A-21-M10-2T	21	10.5	30	M10	2	黛杰DUJETWVO**05**	M3*6	T10	●	0.08
MSH06-25-M12-2T	MSH06-A-25-M12-2T	25	12.5	35	M12	2	黛杰DUJETWVO**06**	M3*6	T15	●	0.12
MSH06-26-M12-2T	MSH06-A-26-M12-2T	26	12.5	35	M12	2	黛杰DUJETWVO**06**	M4*8	T15	●	0.12
MSH06-30-M16-2T	MSH06-A-30-M16-2T	30	17	35	M16	2	黛杰DUJETWVO**06**	M4*8	T15	●	0.13
MSH06-32-M16-3T	MSH06-A-32-M16-3T	32	17	35	M16	3	黛杰DUJETWVO**06**	M4*8	T15	●	0.15
MSH08-32-M16-2T	MSH08-A-32-M16-2T	32	17	35	M16	2	黛杰DUJETWVO**08**	M4.5*10	T20	●	0.15
MSH08-35-M16-2T	MSH08-A-35-M16-2T	35	17	40	M16	2	黛杰DUJETWVO**08**	M4.5*10	T20	●	0.18

注Note: ●现货Spot, △交货时间短Short delivery time, O交货时间长Long delivery time.

车削系列
Turning Series

铣削系列
Milling Series

搪系列
Fine Broing Series

车削系列
Turning Series

铣削系列
Milling Series

搪系列
Fine Broing Series

锁牙式铣刀头

Indexable Modular Cutter Heads

锁牙式铣刀头MRN系列

Modular Cutter Head MRN Series

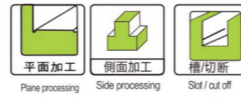
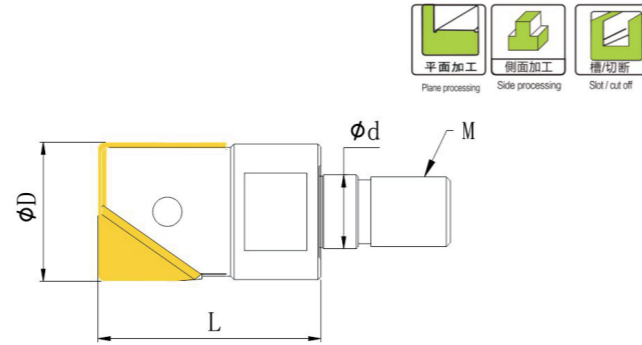

规格型号 Item code		尺寸毫米 Dimensions(mm)				刃数 Teeth	刀片规格 Insert	螺丝 Screw	扳手 Wrench	备货情况 Inventory	重量 Weight(kg)
无出水孔 No OutletHole	出水孔 Outlet Hole	D	d	L	M						
MRN-10-M5-1T	MRN-A-10-M5-1T	10	5.5	18	M5	1	黛杰 DUJETRNM-100 HRM-100/110	M3*8	T8	●	0.04
MRN-10-M6-1T	MRN-A-10-M6-1T	10	6.5	20	M6	1	黛杰 DUJETRNM-100 HRM-100/110	M3*8	T8	●	0.04
MRN-12-M6-1T	MRN-A-12-M6-1T	12	6.5	20	M6	1	黛杰 DUJETRNM-120/130HRM-120/130	M3.5*9.6	T15	●	0.05
MRN-16-M8-1T	MRN-A-16-M8-1T	16	8.5	26	M8	1	黛杰 DIJETRNM-160/170 HRM-160/170	M4*13.5	T15	●	0.06
MRN-20-M10-1T	MRN-A-20-M10-1T	20	10.5	30	M10	1	黛杰DUJET-RNM-200/220***HRM-200/220	M5*16.4	T20	●	0.08
MRN-25-M12-1T	MRN-A-25-M12-1T	25	12.5	35	M12	1	黛杰 DIJETRNM-200/220 HRM-200/220	M6*20	T30	●	0.10
MRN-30-M16-1T	MRN-A-30-M16-1T	30	17	43	M16	1	黛杰DUJETRNM-300	M8*25	T40	●	0.12
MRN-32-M16-1T	MRN-A-32-M16-1T	32	17	43	M16	1	黛杰DUJETRNM-320	M8*25	T40	●	0.15

注Note: ●现货Spot, △交货时间短Short delivery time, O交货时间长Long delivery time.

锁牙式铣刀头 MBN系列

Modular Cutter Head BNM Series

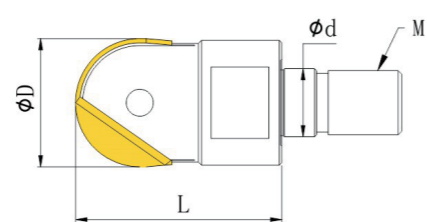

规格型号 Item code		尺寸毫米 Dimensions(mm)				刃数 Teeth	刀片规格 Insert	螺丝 Screw	扳手 Wrench	备货情况 Inventory	重量 Weight(kg)
无出水孔 No OutletHole	出水孔 Outlet Hole	D	d	L	M						
MBN-R3-M3-1T	MBN-A-R3-M3-1T	6	3.5	15	M3	1	黛杰Dijet BNM-60	M2*5.0	T6	●	0.10
MBN-R4-M4-1T	MBN-A-R4-M4-1T	8	4.5	15	M4	1	黛杰Dijet BNM-80	M2.5*6.6	T7	●	0.13
MBN-R5-M5-1T	MBN-A-R5-M5-1T	10	5.5	20	M5	1	黛杰Dijet BNM-100	M3*8.0	T8	●	0.15
MBN-R6-M6-1T	MBN-A-R6-M6-1T	12	6.5	26	M6	1	黛杰Dijet BNM-120	M3.5*9.6	T10	●	0.15
MBN-R8-M8-1T	MBN-A-R8-M8-1T	16	8.5	28	M8	1	黛杰Dijet BNM-160	M4*13.5	T15	●	0.20
MBN-R10-M10-1T	MBN-A-R10-M10-1T	20	10.5	30	M10	1	黛杰Dijet BNM-200	M5*16.4	T20	●	0.25
MBN-R12.5-M12-1T	MBN-A-R12.5-M12-1T	25	12.5	35	M12	1	黛杰Dijet BNM-250	M6*20	T30	●	0.25
MBN-R15-M16-1T	MBN-A-R15-M16-1T	30	17	40	M16	1	黛杰Dijet BNM-300	M8*25	T40	●	0.30

注Note: ●现货Spot, △交货时间短Short delivery time, O交货时间长Long delivery time.

锁牙式铣刀头

Indexable Modular Cutter Heads

锁牙式铣刀头 MOX 系列

Modular Cutter Head MQX Series

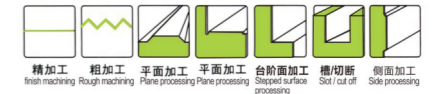
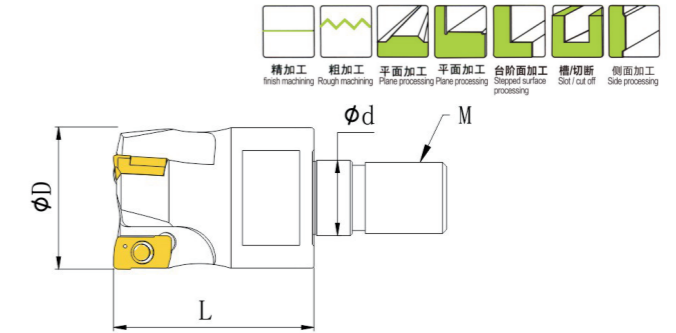

规格型号 Item code		尺寸毫米 Dimensions(mm)				刃数 Teeth	刀片规格 Insert	螺丝 Screw	扳手 Wrench	备货情况 Inventory	重量 Weight(kg)
无出水孔 No OutletHole	出水孔 Outlet Hole	D	d	L	M						
MQX-16-M8-2T	MQX-A-16-M8-2T	16	8.5	26	M8	2	黛杰DUJETP**1003** Z*RZPMT1003** ZERYPHW1003** ZER-**	M2.5*6.0	T8	●	0.18
MQX-17-M8-2T	MQX-A-17-M8-2T	17	8.5	26	M8	2		M2.5*6.0	T8	●	0.18
MQX-20-M10-3T	MQX-A-20-M10-3T	20	10.5	30	M10	3		M2.5*6.0	T8	●	0.2
MQX-20-M10-4T	MQX-A-20-M10-4T	20	10.5	30	M10	4		M2.5*6.0	T8	●	0.2
MQX-21-M10-3T	MQX-A-21-M10-3T	21	10.5	30	M10	3		M2.5*6.0	T8	●	0.22
MQX-21-M10-4T	MQX-A-21-M10-4T	21	10.5	30	M10	4		M2.5*6.0	T8	●	0.22
MQX-25-M12-4T	MQX-A-25-M12-4T	25	12.5	35	M12	4		M2.5*6.0	T8	●	0.25
MQX-25-M12-5T	MQX-A-25-M12-5T	25	12.5	35	M12	5		M2.5*6.0	T8	●	0.25
MQX-26-M12-3T	MQX-A-26-M12-3T	26	12.5	35	M12	3		M2.5*6.0	T8	●	0.28
MQX-26-M12-4T	MQX-A-26-M12-4T	26	12.5	35	M12	4		M2.5*6.0	T8	●	0.28
MQX-26-M12-5T	MQX-A-26-M12-5T	26	12.5	35	M12	5		M2.5*6.0	T8	●	0.25
MQX-32-M16-5T	MQX-A-32-M16-5T	32	17	35	M16	5		M2.5*6.0	T8	●	0.25

注Note: ●现货Spot, △交货时间短Short delivery time, O交货时间长Long delivery time.

锁牙式铣刀头SDH系列

Modular Cutter Head SDH series

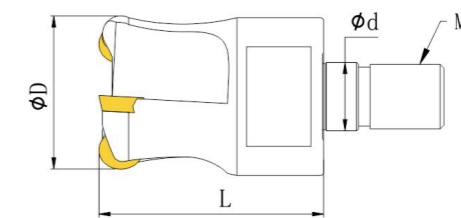

规格型号 Item code		尺寸毫米 Dimensions(mm)				刃数 Teeth	刀片规格 Insert	螺丝 Screw	扳手 Wrench	备货情况 Inventory	重量 Weight(kg)
无出水孔 No OutletHole	出水孔 Outlet Hole	D	d	L	M						
SDH3.5R-16-M8-2T	SDH3.5R-A-16-M8-2T	16	8.5	26	M8	2	RD**D0702MOT黛杰	M2.5*6	T8	●	0.08
SDH3.5R-17-M8-2T	SDH3.5R-A-17-M8-2T	17	8.5	26	M8	2	RD**0702MOT黛杰	M2.5*6	T8	●	0.08
SDH3.5R-20-M10-3T	SDH3.5R-A-20-M10-3T	20	10.5	30	M10	3	RD**0702MOT黛杰	M2.5*6	T8	●	0.12
SDH3.5R-21-M10-3T	SDH3.5R-A-21-M10-3T	21	10.5	30	M10	3	RD**0702MOT黛杰	M2.5*6	T8	●	0.15
SDH5R-21-M10-2T	SDH5R-A-21-M10-2T	21	10.5	30	M10	2	RD**1004MOT黛杰	M4*8	T15	●	0.15
SDH5R-25-M12-3T	SDH5R-A-25-M12-3T	25	12.5	35	M12	3	RD**1004MOT黛杰	M4*8	T15	●	0.25
SDH5R-26-M12-3T	SDH5R-A-26-M12-3T	26	12.5	35	M12	3	RD**1004MOT黛杰	M4*8	T15	●	0.25

注Note: ●现货Spot, △交货时间短Short delivery time, O交货时间长Long delivery time.

车削系列
Turning Series

铣削系列
Milling Series

搪系列
Fine Broing Series

车削系列
Turning Series

铣削系列
Milling Series

搪系列
Fine Broing Series

锁牙式铣刀头

Indexable Modular Cutter Heads

锁牙式铣刀头MPM系列

Modular Cutter Head MPM Series

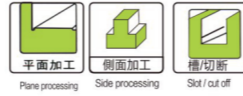
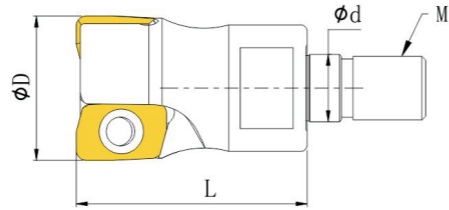

规格型号 Item code		尺寸毫米 Dimensions(mm)				刃数 Teeth	刀片规格 Insert	螺丝 Screw	扳手 Wrench	备货情况 Inventory	重量 Weight (kg)
无出水孔 No OutletHole	出水孔 Outlet Hole	D	d	L	M						
MPM-10-M5-2T	MPM-A-10-M5-2T	10	5.5	18	M5	2		M1.8*4.0	T6	●	0.04
MPM-10-M6-2T	MPM-A-10-M6-2T	10	6.5	18	M6	2		M1.8*4.0	T6	●	0.04
MPM-11-M5-2T	MPM-A-11-M5-2T	11	5.5	18	M5	2		M1.8*4.0	T6	●	0.05
MPM-11-M6-2T	MPM-A-11-M6-2T	11	6.5	18	M6	2		M1.8*4.0	T6	●	0.05
MPM-12-M6-3T	MPM-A-12-M6-3T	12	6.5	20	M6	3		M1.8*4.0	T6	●	0.06
MPM-13-M6-3T	MPM-A-13-M6-3T	13	6.5	20	M6	3		M1.8*4.0	T6	●	0.07
MPM-16-M8-4T	MPM-A-16-M8-4T	16	8.5	23	M8	4	黛杰DijetEOM*ZERZOMT** ZEREHOHWTRZOMT*	M1.8*4.0	T6	●	0.10
MPM-17-M8-4T	MPM-A-17-M8-4T	17	8.5	23	M8	4	ZERYOHW**ZER-12	M1.8*4.0	T6	●	0.12
MPM-20-M10-3T	MPM-A-20-M10-3T	20	10.5	30	M10	3		M1.8*4.0	T6	●	0.16
MPM-21-M10-3T	MPM-A-21-M10-3T	21	10.5	30	M10	3		M1.8*4.0	T6	●	0.18
MPM-25-M12-3T	MPM-A-25-M12-3T	25	12.5	35	M12	3		M1.8*4.0	T6	●	0.22
MPM-25-M12-5T	MPM-A-25-M12-5T	25	12.5	35	M12	5		M1.8*4.0	T6	●	0.22
MPM-30-M16-5T	MPM-A-30-M16-5T	30	17	43	M16	5		M1.8*4.0	T6	●	0.30
MPM-32-M16-5T	MPM-A-32-M16-5T	32	17	43	M16	5		M1.8*4.0	T6	●	0.35

注Note: ●现货Spot, △交货时间短Short delivery time, O交货时间长Long delivery time.

锁牙式铣刀头

Indexable Modular Cutter Heads

锁牙式铣刀头MFH03系列

Modular Cutter Head MFH03 series

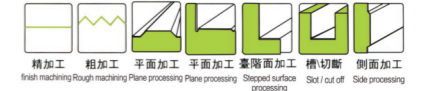
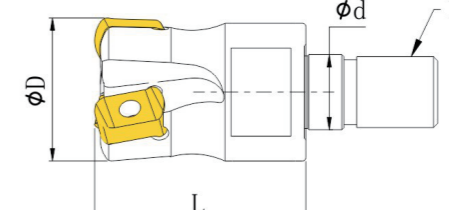

规格型号 Item code		尺寸毫米 Dimensions(mm)				刃数 Teeth	刀片规格 Insert	螺丝 Screw	扳手 Wrench	备货情况 Inventory	重量 Weight (kg)
无出水孔 No OutletHole	出水孔 Outlet Hole	D	d	L	M						
MFH03-16-M8-2T	MFH03-A-16-M8-2T	16	8.5	26	M8	2	京瓷KyoceraLOGU030310ER	M3.0*7.0	T8	●	0.12
MFH03-17-M8-2T	MFH03-A-17-M8-2T	17	8.5	26	M8	2	京瓷KyoceraLOGU030310ER	M3.0*7.0	T8	●	0.15
MFH03-20-M10-3T	MFH03-A-20-M10-3T	20	10.5	30	M10	3	京瓷KyoceraLOGU030310ER	M3.0*7.0	T8	●	0.20
MFH03-21-M10-3T	MFH03-A-21-M10-3T	21	10.5	30	M10	3	京瓷KyoceraLOGU030310ER	M3.0*7.0	T8	●	0.20
MFH03-25-M12-4T	MFH03-A-25-M12-4T	25	12.5	35	M12	4	京瓷KyoceraLOGU030310ER	M3.0*7.0	T8	●	0.25
MFH03-26-M12-4T	MFH03-A-26-M12-4T	26	12.5	35	M12	4	京瓷KyoceraLOGU030310ER	M3.0*7.0	T8	●	0.26
MFH03-32-M16-5T	MFH03-A-32-M16-5T	32	17	40	M16	5	京瓷KyoceraLOGU030310ER	M3.0*7.0	T8	●	0.30
MFH03-33-M16-5T	MFH03-A-33-M16-5T	33	17	40	M16	5	京瓷KyoceraLOGU030310ER	M3.0*7.0	T8	●	0.35
MFH03-35-M16-5T	MFH03-A-35-M16-5T	35	17	40	M16	5	京瓷KyoceraLOGU030310ER	M3.0*7.0	T8	●	0.40

注Note: ●现货Spot, △交货时间短Short delivery time, O交货时间长Long delivery time.

锁牙式铣刀头MFH10系列

Modular Cutter Head MFH10 series

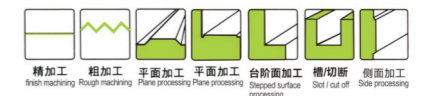
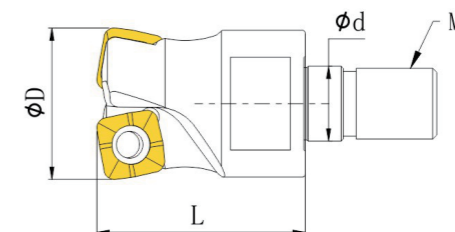

规格型号 Item code		尺寸毫米 Dimensions(mm)				刃数 Teeth	刀片规格 Insert	螺丝 Screw	扳手 Wrench	备货情况 Inventory	重量 Weight (kg)
无出水孔 No OutletHole	出水孔 Outlet Hole	D	d	L	M						
MFH10-26-M12-2T	MFH10-A-26-M12-2T	26	12.5	35	M12	2	京瓷KyoceraSOMT 100420ER-GMSOMT	M4*9.0	T15	●	0.25
MFH10-32-M16-3T	MFH10-A-32-M16-3T	32	17	40	M16	3	100420ER-LDSOMT	M4*9.0	T15	●	0.32
MFH10-35-M16-3T	MFH10-A-35-M16-3T	35	17	40	M16	3	100420ER-FL	M4*9.0	T15	●	0.35
MFH10-40-M16-4T	MFH10-A-40-M16-4T	40	17	40	M16	4		M4*9.0	T15	●	0.40

注Note: ●现货Spot, △交货时间短Short delivery time, O交货时间长Long delivery time.

车削系列
Turning Series

铣削系列
Milling Series

搪系列
Fine Broing Series

车削系列
Turning Series

铣削系列
Milling Series

搪系列
Fine Broing Series

锁牙式铣刀头

Indexable Modular Cutter Heads

锁牙式铣刀头MFWN90系列

Modular Cutter Head MFWN90 series

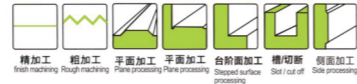
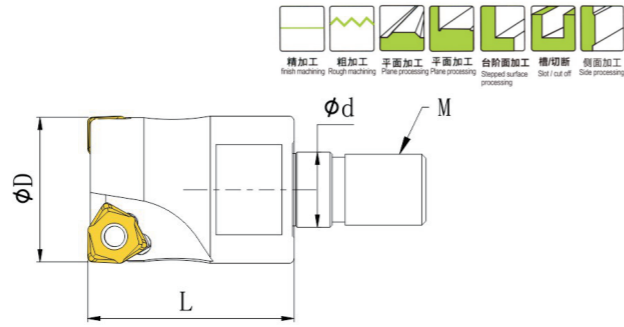

规格型号 Item code		尺寸毫米 Dimensions(mm)				刃数 Teeth	刀片规格 Insert	螺丝 Screw	扳手 Wrench	备货情况 Inventory	重量 Weight(kg)
无出水孔 No OutletHole	出水孔 Outlet Hole	D	d	L	M						
MFWN90-25-M12-2T	MFWN90-A-25-M12-2T	25	12.5	35	M12	2	京瓷 KyoceraWNMU050408	M3.0*8.0	T8	●	0.25
MFWN90-26-M12-2T	MFWN90-A-26-M12-2T	26	12.5	35	M12	2	京瓷 KyoceraWNMU050408	M3.0*8.0	T8	●	0.25
MFWN90-32-M16-3T	MFWN90-A-32-M16-3T	32	17.0	40	M16	3	京瓷 KyoceraWNMU050408	M3.0*8.0	T8	●	0.32
MFWN90-35-M16-3T	MFWN90-A-35-M16-3T	35	17.0	40	M16	3	京瓷 KyoceraWNMU050408	M3.0*8.0	T8	●	0.35

注Note: ●现货Spot, △交货时间短Short delivery time, O交货时间长Long delivery time.

锁牙式铣刀头MFHM系列

Modular Cutter Head MFHM series

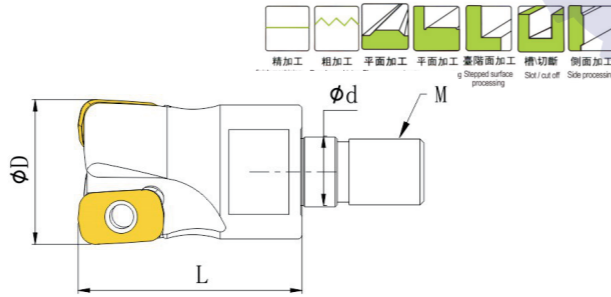

规格型号 Item code		尺寸毫米 Dimensions(mm)				刃数 Teeth	刀片规格 Insert	螺丝 Screw	扳手 Wrench	备货情况 Inventory	重量 Weight(kg)
无出水孔 No OutletHole	出水孔 Outlet Hole	D	d	L	M						
MFHM-8-M4-1T	MFHM-A-8-M4-1T	8	4.5	15	M4	1	京瓷KyoceraLPGT010210ER-GM	M1.8*4.0	T6	●	0.06
MFHM-9-M4-1T	MFHM-A-9-M4-1T	9	4.5	15	M4	1	京瓷KyoceraLPGT010210ER-GM	M1.8*4.0	T6	●	0.06
MFHM-10-M5-2T	MFHM-A-10-M5-2T	10	5.5	18	M5	2	京瓷KyoceraLPGT010210ER-GM	M1.8*4.0	T6	●	0.08
MFHM-10-M6-2T	MFHM-A-10-M6-2T	10	6.5	20	M6	2	京瓷KyoceraLPGT010210ER-GM	M1.8*4.0	T6	●	0.08
MFHM-11-M5-2T	MFHM-A-11-M5-2T	11	5.5	18	M5	2	京瓷KyoceraLPGT010210ER-GM	M1.8*4.0	T6	●	0.10
MFHM-11-M6-2T	MFHM-A-11-M6-2T	11	6.5	20	M6	3	京瓷KyoceraLPGT010210ER-GM	M1.8*4.0	T6	●	0.10
MFHM-12-M6-3T	MFHM-A-12-M6-3T	12	6.5	20	M6	3	京瓷KyoceraLPGT010210ER-GM	M1.8*4.0	T6	●	0.12
MFHM-13-M6-3T	MFHM-A-13-M6-3T	13	6.5	20	M6	4	京瓷KyoceraLPGT010210ER-GM	M1.8*4.0	T6	●	0.12
MFHM-16-M8-4T	MFHM-A-16-M8-4T	16	8.5	26	M8	4	京瓷KyoceraLPGT010210ER-GM	M1.8*4.0	T6	●	0.15
MFHM-17-M8-4T	MFHM-A-17-M8-4T	17	8.5	26	M8	4	京瓷KyoceraLPGT010210ER-GM	M1.8*4.0	T6	●	0.15

注Note: ●现货Spot, △交货时间短Short delivery time, O交货时间长Long delivery time.

锁牙式铣刀头

Indexable Modular Cutter Heads

锁牙式铣刀头EXN03系列

Modular Cutter Head EXN series

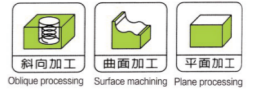
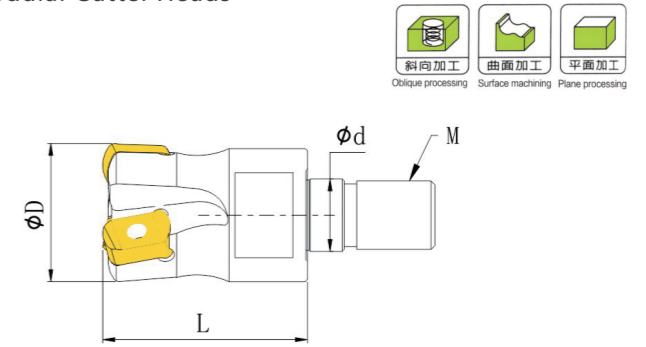

规格型号 Item code		尺寸毫米 Dimensions(mm)				刃数 Teeth	刀片规格 Insert	螺丝 Screw	扳手 Wrench	备货情况 Inventory	重量 Weight(kg)
无出水孔 No OutletHole	出水孔 Outlet Hole	D	d	L	M						
EXN03-16-M8-2T	EXN03-A-16-M8-2T	16	8.5	26	M8	2	东芝ToshibaLNMU0303	M2.5*6.0	T8	●	0.04
EXN03-17-M8-2T	EXN03-A-17-M8-2T	17	8.5	26	M8	2	东芝ToshibaLNMU0303	M2.5*6.0	T8	●	0.04
EXN03-20-M10-3T	EXN03-A-20-M10-3T	20	10.5	30	M10	3	东芝ToshibaLNMU0303	M2.5*6.0	T8	●	0.07
EXN03-21-M10-3T	EXN03-A-21-M10-3T	21	10.5	30	M10	3	东芝ToshibaLNMU0303	M2.5*6.0	T8	●	0.07
EXN03-25-M12-4T	EXN03-A-25-M12-4T	25	12.5	35	M12	4	东芝ToshibaLNMU0303	M2.5*6.0	T8	●	0.12
EXN03-26-M12-4T	EXN03-A-26-M12-4T	26	12.5	35	M12	4	东芝ToshibaLNMU0303	M2.5*6.0	T8	●	0.12
EXN03-32-M16-5T	EXN03-A-32-M16-5T	32	17	40	M16	5	东芝ToshibaLNMU0303	M2.5*6.0	T8	●	0.26
EXN03-33-M16-5T	EXN03-A-33-M16-5T	33	17	40	M16	5	东芝ToshibaLNMU0303	M2.5*6.0	T8	●	0.26
EXN03-35-M16-5T	EXN03-A-35-M16-5T	35	17	40	M16	5	东芝ToshibaLNMU0303	M2.5*6.0	T8	●	0.34

注Note: ●现货Spot, △交货时间短Short delivery time, O交货时间长Long delivery time.

锁牙式铣刀头STN系列

Modular Cutter Head STN series

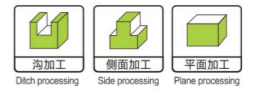
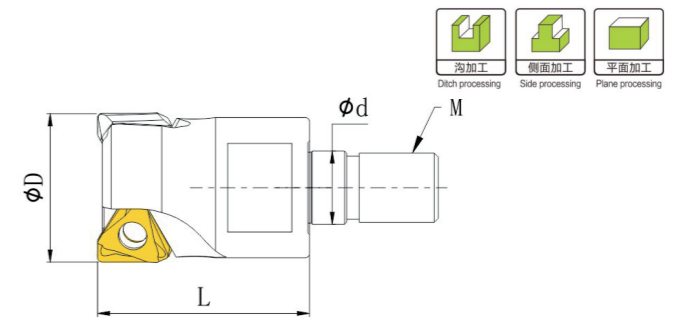

规格型号 Item code		尺寸毫米 Dimensions(mm)				刃数 Teeth	刀片规格 Insert	螺丝 Screw	扳手 Wrench	备货情况 Inventory	重量 Weight(kg)
无出水孔 No OutletHole	出水孔 Outlet Hole	D	d	L	M						
STN10-17-M8-2T	STN10-A-17-M8-2T	17	8.5	26	M8	2	普拉米特DORMER/PRAMETTNGX1004	M3*9.0	T8	●	0.15
STN10-20-M10-2T	STN10-A-20-M10-2T	20	10.5	30	M10	2	普拉米特DORMER/PRAMETTNGX1004	M3*9.0	T8	●	0.20
STN10-21-M10-2T	STN10-A-21-M10-2T	21	10.5	30	M10	2	普拉米特DORMER/PRAMETTNGX1004	M3*9.0	T8	●	0.20
STN10-25-M12-2T	STN10-A-25-M12-2T	25	12.5	35	M12	2	普拉米特DORMER/PRAMETTNGX1004	M3*9.0	T8	●	0.25
STN10-26-M12-2T	STN10-A-26-M12-2T	26	12.5	35	M12	2	普拉米特DORMER/PRAMETTNGX1004	M3*9.0	T8	●	0.25
STN10-32-M16-3T	STN10-A-32-M16-3T	32	17.0	40	M16	3	普拉米特DORMER/PRAMETTNGX1004	M3*9.0	T8	●	0.32
STN16-25-M12-2T	STN16-A-25-M12-2T	25	12.5	35	M12	2	普拉米特DORMER/PRAMETTNGX16	M4*9.0	T15	●	0.25
STN16-26-M12-2T	STN16-A-26-M12-2T	26	12.5	35	M12	2	普拉米特DORMER/PRAMETTNGX16	M4*9.0	T15	●	0.25
STN16-32-M16-2T	STN16-A-32-M16-2T	32	17.0	40	M16	2	普拉米特DORMER/PRAMETTNGX16	M4*9.0	T15	●	0.32
STN16-35-M16-3T	STN16-A-35-M16-3T	35	17.0	40	M16	3	普拉米特DORMER/PRAMETTNGX16	M4*9.0	T15	●	0.35
STN16-40-M16-4T	STN16-A-40-M16-4T	40	17.0	40	M16	4	普拉米特DORMER/PRAMETTNGX16	M4*9.0	T15	●	0.40

注Note: ●现货Spot, △交货时间短Short delivery time, O交货时间长Long delivery time.

车削系列
Turning Series

铣削系列
Milling Series

搪系列
Fine Broing Series

车削系列
Turning Series

铣削系列
Milling Series

搪系列
Fine Broing Series

锁牙式铣刀头

Indexable Modular Cutter Heads

锁牙式铣刀头MEC系列

Modular Cutter Head MEC series

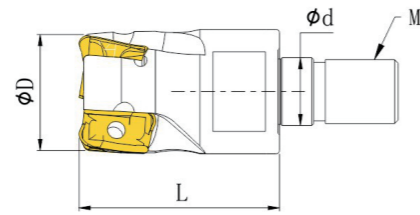

规格型号 Item code		尺寸毫米 Dimensions(mm)				刃数 Teeth	刀片规格 Insert	螺丝 Screw	扳手 Wrench	备货情况 Inventory	重量 Weight(kg)
无出水孔 No OutletHole	出水孔 Outlet Hole	D	d	L	M						
MEC07-10-M5-2T	MEC07-A-10-M5-2T	10	5.5	18	M5	2	京瓷KyoceraBDMT0703*	M2.0*5.0	T6	●	0.01
MEC07-11-M5-2T	MEC07-A-11-M5-2T	11	5.5	18	M5	2	京瓷KyoceraBDMT0703*	M2.0*5.0	T6	●	0.01
MEC07-12-M6-2T	MEC07-A-12-M6-2T	12	6.5	20	M6	2	京瓷KyoceraBDMT0703*	M2.0*5.0	T6	●	0.01
MEC07-13-M6-2T	MEC07-A-13-M6-2T	13	6.5	20	M6	2	京瓷KyoceraBDMT0703*	M2.0*5.0	T6	●	0.02
MEC11-16-M8-2T	MEC11-A-16-M8-2T	16	8.5	26	M8	2	京瓷KyoceraBDMT1104*	M2.5*6.0	T9	●	0.04
MEC11-17-M8-2T	MEC11-A-17-M8-2T	17	8.5	26	M8	3	京瓷KyoceraBDMT1104*	M2.5*6.0	T9	●	0.04
MEC11-20-M10-3T	MEC11-A-20-M10-3T	20	10.5	30	M10	3	京瓷KyoceraBDMT1104*	M2.5*6.0	T9	●	0.07
MEC11-21-M10-3T	MEC11-A-21-M10-3T	21	10.5	30	M10	3	京瓷KyoceraBDMT1104*	M2.5*6.0	T9	●	0.07
MEC11-25-M12-4T	MEC11-A-25-M12-4T	25	12.5	35	M12	4	京瓷KyoceraBDMT1104*	M2.5*6.0	T9	●	0.14
MEC11-26-M12-3T	MEC11-A-26-M12-3T	26	12.5	35	M12	3	京瓷KyoceraBDMT1104*	M2.56.0	T9	●	0.14
MEC11-32-M16-4T	MEC11-A-32-M16-4T	32	17	40	M16	4	京瓷KyoceraBDMT1104*	M2.5*6.0	T9	●	0.29
MEC11-32M16-5T	MEC11-A-32-M16-5T	32	17	40	M16	5	京瓷KyoceraBDMT1104*	M2.5*6.0	T9	●	0.29
MEC11-33-M16-4T	MEC11-A-33-M16-4T	33	17	40	M16	4	京瓷KyoceraBDMT1104*	M2.5*6.0	T9	●	0.29
MEC11-40-M16-6T	MEC11-A-40-M16-6T	40	17	40	M16	6	京瓷KyoceraBDMT1104*	M2.5*6.0	T9	●	0.40

注Note: ●现货Spot, △交货时间短Short delivery time, O交货时间长Long delivery time.

锁牙式铣刀头4NTE90系列

Modular Cutter Head 4NTE90 series

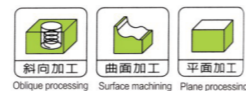
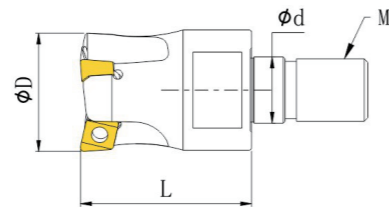

规格型号 Item code		尺寸毫米 Dimensions(mm)				刃数 Teeth	刀片规格 Insert	螺丝 Screw	扳手 Wrench	备货情况 Inventory	重量 Weight(kg)
无出水孔 No OutletHole	出水孔 Outlet Hole	D	d	L	M						
4NTE9006-16-M8-2T	4NTE9006-A-16-M8-2T	16	8.5	26	M8	2	特固克Taegu Tec4NKT0603...	M3*7	T8	●	0.15
4NTE9006-17-M8-2T	4NTE9006-A-17-M8-2T	17	8.5	26	M8	2	特固克Taegu Tec4NKT0603...	M3*7	T8	●	0.15
4NTE9006-20-M10-2T	4NTE9006-A-20-M10-2T	20	10.5	30	M10	2	特固克Taegu Tec4NKT0603...	M3*7	T8	●	0.20
4NTE9006-21-M10-3T	4NTE9006-A-21-M10-3T	21	10.5	30	M10	3	特固克Taegu Tec4NKT0603...	M3*7	T8	●	0.20
4NTE9006-25-M12-3T	4NTE9006-A-25-M12-3T	25	12.5	35	M12	3	特固克Taegu Tec4NKT0603...	M3*7	T8	●	0.25
4NTE9006-26-M12-4T	4NTE9006-A-26-M12-4T	26	12.5	35	M12	4	特固克Taegu Tec4NKT0603...	M3*7	T8	●	0.25

注Note: ●现货Spot, △交货时间短Short delivery time, O交货时间长Long delivery time.

锁牙式铣刀头

Indexable Modular Cutter Heads

锁牙式铣刀头TE90A系列

Modular Cutter Head TE90A series

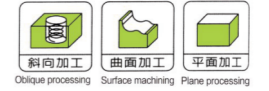
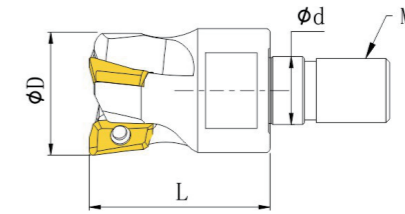

规格型号 Item code		尺寸毫米 Dimensions(mm)				刃数 Teeth	刀片规格 Insert	螺丝 Screw	扳手 Wrench	备货情况 Inventory	重量 Weight(kg)
无出水孔 No OutletHole	出水孔 Outlet Hole	D	d	L	M						
TE90A06-9-M4-1T	TE90A06-A-9-M4-1T	9	4.5	15	M4	1	特固克Taegu TecAXMT0602**	M1.8*4.0	T6	●	0.02
TE90A06-10-M5-2T	TE90A06-A-10-M5-2T	10	5.5	18	M5	2	特固克Taegu TecAXMT0602**	M1.8*4.0	T6	●	0.02
TE90A06-11-M5-2T	TE90A06-A-11-M5-2T	11	5.5	18	M5	2	特固克Taegu TecAXMT0602**	M1.8*4.0	T6	●	0.02
TE90A06-12-M6-2T	TE90A06-A-12-M6-2T	12	6.5	20	M6	2	特固克Taegu TecAXMT0602**	M1.8*4.0	T6	●	0.03
TE90A06-12-M6-3T	TE90A06-A-12-M6-3T	12	6.5	20	M6	3	特固克Taegu TecAXMT0602**	M1.8*4.0	T6	●	0.03
TE90A06-13-M6-2T	TE90A06-A-13-M6-2T	13	6.5	20	M6	2	特固克Taegu TecAXMT0602**	M1.8*4.0	T6	●	0.03
TE90A06-13-M6-3T	TE90A06-A-13-M6-3T	13	6.5	20	M6	3	特固克Taegu TecAXMT0602**	M1.8*4.0	T6	●	0.03
TE90A06-16-M8-3T	TE90A06-A-16-M8-3T	16	8.5	26	M8	3	特固克Taegu TecAXMT0602**	M1.8*4.0	T6	●	0.04
TE90A06-16-M8-4T	TE90A06-A-16-M8-4T	16	8.5	26	M8	4	特固克Taegu TecAXMT0602**	M1.8*4.0	T6	●	0.04
TE90A06-17-M8-3T	TE90A06-A-17-M8-3T	17	8.5	26	M8	3	特固克Taegu TecAXMT0602**	M1.8*4.0	T6	●	0.05
TE90A06-17-M8-4T	TE90A06-A-17-M8-4T	17	8.5	26	M8	4	特固克Taegu TecAXMT0602**	M1.8*4.0	T6	●	0.04
TE90A09-16-M8-2T	TE90A09-A-16-M8-2T	16	8.5	26	M8	2	特固克Taegu TecAPKT09T03**	M2.5*6.0	T9	●	0.05
TE90A09-17-M8-2T	TE90A09-A-17-M8-2T	17	8.5	26	M8	2	特固克Taegu TecAPKT09T03**	M2.5*6.0	T9	●	0.05
TE90A09-20-M10-2T	TE90A09-A-20-M10-2T	20	10.5	30	M10	2	特固克Taegu TecAPKT09T03**	M2.5*6.0	T9	●	0.07
TE90A09-20-M10-3T	TE90A09-A-20-M10-3T	20	10.5	30	M10	3	特固克Taegu TecAPKT09T03**	M2.5*6.0	T9	●	0.07
TE90A09-21-M10-2T	TE90A09-A-21-M10-2T	21	10.5	30	M10	2	特固克Taegu TecAPKT09T03**	M2.5*6.0	T9	●	0.07
TE90A09-21-M10-3T	TE90A09-A-21-M10-3T	21	10.5	30	M10	3	特固克Taegu TecAPKT09T03**	M2.5*6.0	T9	●	0.07
TE90A09-25-M12-3T	TE90A09-A-25-M12-3T	25	12.5	35	M12	3	特固克Taegu TecAPKT09T03**	M2.5*6.0	T9	●	0.12
TE90A09-26-M12-3T	TE90A09-A-26-M12-3T	26	12.5	35	M12	3	特固克Taegu TecAPKT09T03**	M2.5*6.0	T9	●	0.12
TE90A09-26-M12-4T	TE90A09-A-26-M12-4T	26	12.5	35	M12	4	特固克Taegu TecAPKT09T03**	M2.5*6.0	T9	●	0.12
TE90A09-33-M16-3T	TE90A09-A-33-M16-3T	33	17	40	M16	3	特固克Taegu TecAPKT09T03**	M2.5*6.0	T9	●	0.25
TE90A09-35-M16-3T	TE90A09-A-35-M16-3T	35	17	40	M16	3	特固克Taegu TecAPKT09T03**	M2.5*6.0	T9	●	0.26
TE90A09-35-M16-4T	TE90A09-A-35-M16-4T	35	17	40	M16	4	特固克Taegu TecAPKT09T03**	M2.5*6.0	T9	●	0.26

注Note: ●现货Spot, △交货时间短Short delivery time, O交货时间长Long delivery time.

锁牙式铣刀头

Indexable Modular Cutter Heads

锁牙式铣刀头RT系列

Modular Cutter Head RT Series

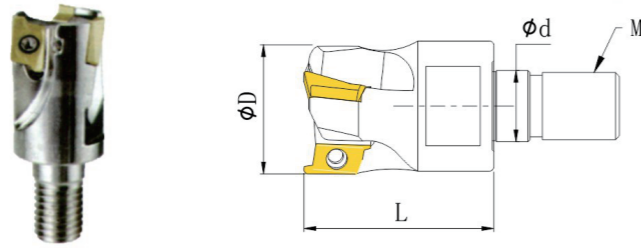

规格型号 Item code		尺寸毫米 Dimensions(mm)				刃数 Teeth	刀片规格 Insert	螺丝 Screw	扳手 Wrench	备货情况 Inventory	重量 Weight(kg)
无出水孔 No OutletHole	出水孔 Outlet Hole	D	d	L	M						
RT07-9-M4-1T	RT07-A-9-M4-1T	9	4.5	15	M4	1	法国French(Safety)RTO702**	M2.0*4.0	T6	○	0.02
RT07-10-M5-2T	RT07-A-10-M5-2T	10	5.5	18	M5	2	法国French(Safety)RTO702**	M2.0*4.0	T6	○	0.02
RT07-11-M5-2T	RT07-A-11-M5-2T	11	5.5	18	M5	2	法国French(Safety)RTO702**	M2.0*4.0	T6	○	0.02
RT07-12-M6-2T	RT07-A-12-M6-2T	12	6.5	20	M6	2	法国French(Safety)RTO702**	M2.0*5.0	T6	○	0.03
RT07-13-M6-2T	RT07-A-13-M6-2T	13	6.5	20	M6	2	法国French(Safety)RTO702**	M2.0*5.0	T6	○	0.03
RT07-16-M8-3T	RT07-A-16-M8-3T	16	8.5	26	M8	3	法国French(Safety)RTO702**	M2.0*5.0	T6	○	0.04
RT07-17-M8-3T	RT07-A-17-M8-3T	17	8.5	26	M8	3	法国French(Safety)RTO702**	M2.0*5.0	T6	○	0.04
RT07-20-M10-4T	RT07-A-20-M10-4T	20	10.5	30	M10	4	法国French(Safety)RTO702**	M2.0*5.0	T6	○	0.08
RT07-21-M10-4T	RT07-A-21-M10-4T	21	10.5	30	M10	4	法国French(Safety)RTO702**	M2.0*5.0	T6	○	0.08
RT10-16-M8-2T	RT10-A-16-M8-2T	16	8.5	26	M8	2	法国French(Safety)RT1003**	M2.5*6.0	T9	○	0.05
RT10-17-M8-2T	RT10-A-17-M8-2T	17	8.5	26	M8	2	法国French(Safety)RT1003**	M2.5*6.0	T9	○	0.05
RT10-20-M10-2T	RT10-A-20-M10-2T	20	10.5	30	M10	2	法国French(Safety)RT1003**	M2.5*6.0	T9	○	0.07
RT10-20-M10-3T	RT10-A-20-M10-3T	20	10.5	30	M10	3	法国French(Safety)RT1003**	M2.5*6.0	T9	○	0.07
RT10-21-M10-2T	RT10-A-21-M10-2T	21	10.5	30	M10	2	法国French(Safety)RT1003**	M2.5*6.0	T9	○	0.07
RT10-21-M10-3T	RT10-A-21-M10-3T	21	10.5	30	M10	3	法国French(Safety)RT1003**	M2.5*6.0	T9	○	0.07
RT10-25-M12-3T	RT10-A-5-M12-3T	25	12.5	35	M12	3	法国French(Safety)RT1003**	M2.5*6.0	T9	○	0.12
RT10-26-M12-3T	RT10-A-26-M12-3T	26	12.5	35	M12	3	法国French(Safety)RT1003**	M2.5*6.0	T9	○	0.12
RT10-26-M12-4T	RT10-A-26-M12-4T	26	12.5	35	M12	4	法国French(Safety)RT1003**	M2.5*6.0	T9	○	0.15
RT10-32-M16-4T	RT10-A-32-M16-4T	32	17	40	M16	4	法国French(Safety)RT1003**	M2.5*6.0	T9	○	0.24
RT10-32-M16-5T	RT10-A-32-M16-5T	32	17	40	M16	5	法国French(Safety)RT1003**	M2.5*6.0	T9	○	0.23
RT10-33-M16-4T	RT10-A-33-M16-4T	33	17	40	M16	4	法国French(Safety)RT1003**	M2.5*6.0	T9	○	0.25
RT10-33-M16-5T	RT10-A-33-M16-5T	33	17	40	M16	5	法国French(Safety)RT1003**	M2.5*6.0	T9	○	0.24
RT10-35-M16-4T	RT10-A-35-M16-4T	35	17	40	M16	4	法国French(Safety)RT1003**	M2.5*6.0	T9	○	0.26
RT10-35-M16-5T	RT10-A-35-M16-5T	35	17	40	M16	5	法国French(Safety)RT1003**	M2.5*6.0	T9	○	0.25

注Note: ●现货Spot, △交货时间短Short delivery time, ○交货时间长Long delivery time.

锁牙式铣刀头

Indexable Modular Cutter Heads

锁牙式铣刀头PPH系列

Modular Cutter Head TE90A Series

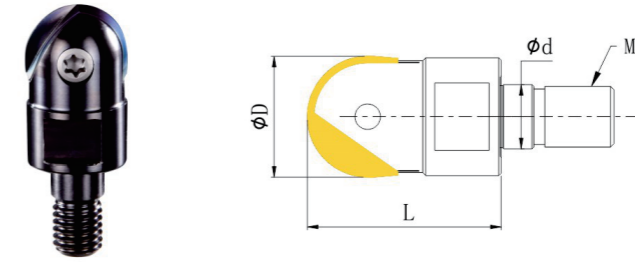
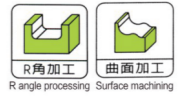

规格型号 Item code		尺寸毫米 Dimensions(mm)				刃数 Teeth	刀片规格 Insert	螺丝 Screw	扳手 Wrench	备货情况 Inventory	重量 Weight(kg)
无出水孔 No OutletHole	出水孔 Outlet Hole	D	d	L	M						
PPH-8-M4-1T	PPH-A-8-M4-1T	8	4.5	15	M4	1	法国French(Safety)PHB08**	M2.5*6.3	T7	●	0.02
PPH-10-M5-1T	PPH-A-10-M5-1T	10	5.5	18	M5	1	法国French(Safety)PHB10**	M3.0*7.8	T8	●	0.02
PPH-12-M6-1T	PPH-A-12-M6-1T	12	6.5	20	M6	1	法国French(Safety)PHB12**	M3.5*9.5	T10	●	0.03
PPH-16-M8-1T	PPH-A-16-M8-1T	16	8.5	28	M8	1	法国French(Safety)PHB16**	M4.0*13.3	T15	●	0.04
PPH-20-M10-1T	PPH-A-20-M10-1T	20	10.5	30	M10	1	法国French(Safety)PHB20**	M5.0*16.25	T20	●	0.07

注Note: ●现货Spot, △交货时间短Short delivery time, ○交货时间长Long delivery time.

锁牙式铣刀头WEM系列

Modular Cutter Head WEM Series

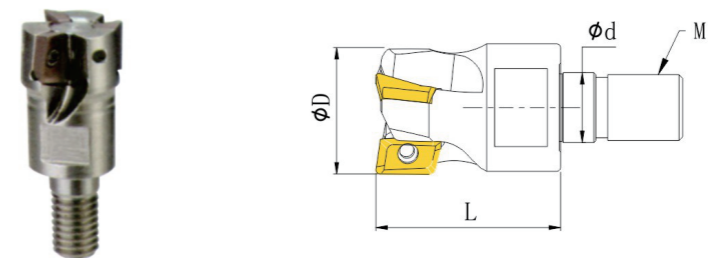
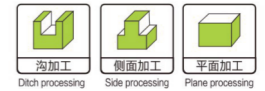

规格型号 Item code		尺寸毫米 Dimensions(mm)				刃数 Teeth	刀片规格 Insert	螺丝 Screw	扳手 Wrench	备货情况 Inventory	重量 Weight(kg)
无出水孔 No OutletHole	出水孔 Outlet Hole	D	d	L	M						
WEM-16-M8-2T	WEM-A-16-M8-2T	16	8.5	26	M8	2	住友SumitomoAPMT1035**	M2.5*6.0	T9	●	0.05
WEM-17-M8-2T	WEM-A-17-M8-2T	17	8.5	26	M8	2	住友SumitomoAPMT1035**	M2.5*6.0	T9	●	0.05
WEM-20-M10-3T	WEM-A-20-M10-3T	20	10.5	30	M10	3	住友SumitomoAPMT1035**	M2.5*6.0	T9	●	0.07
WEM-21-M12-3T	WEM-A-21-M12-3T	21	12.5	30	M12	3	住友SumitomoAPMT1035**	M2.5*6.0	T9	●	0.07
WEM-25-M12-3T	WEM-A-25-M12-3T	25	12.5	35	M12	3	住友SumitomoAPMT1035**	M2.5*6.0	T9	●	0.12
WEM-26-M12-3T	WEM-A-26-M12-3T	26	12.5	35	M12	3	住友SumitomoAPMT1035**	M2.5*6.0	T9	●	0.12

注Note: ●现货Spot, △交货时间短Short delivery time, ○交货时间长Long delivery time.

车削系列
Turning Series

铣削系列
Milling Series

搪系列
Fine Broing Series

车削系列
Turning Series

铣削系列
Milling Series

搪系列
Fine Broing Series

锁牙式铣刀头

Indexable Modular Cutter Heads

锁牙式铣刀头WEX系列

Modular Cutter Head RT Series

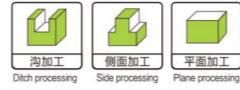
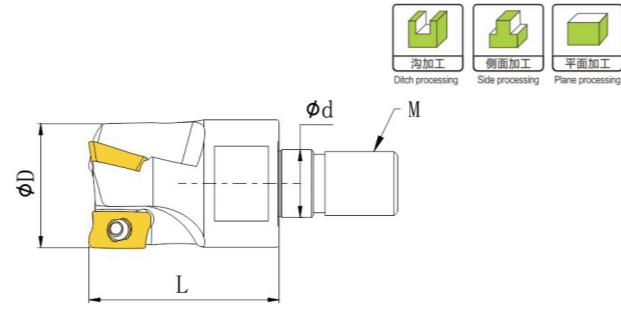

规格型号 Item code		尺寸毫米 Dimensions(mm)				刃数 Teeth	刀片规格 Insert	螺丝 Screw	扳手 Wrench	备货情况 Inventory	重量 Weight(kg)
无出水孔 No OutletHole	出水孔 Outlet Hole	D	d	L	M						
WEX12-10-M5-1T	WEX-A-10-M5-1T	10	5.5	18	M5	1	住友SumitomoAXMT1235***	M3.0*7.0	T9	●	0.02
WEX12-11-M5-1T	WEX-A-11-M5-1T	11	5.5	18	M5	1	住友SumitomoAXMT1235***	M3.0*7.0	T9	●	0.02
WEX12-12-M6-1T	WEX-A-12-M6-1T	12	6.5	20	M6	1	住友SumitomoAXMT1235***	M3.0*7.0	T9	●	0.02
WEX12-13-M6-1T	WEX-A-13-M6-1T	13	6.5	20	M6	1	住友SumitomoAXMT1235***	M3.0*7.0	T9	●	0.03
WEX12-16-M8-2T	WEX-A-16-M8-2T	16	8.5	26	M8	2	住友SumitomoAXMT1235***	M3.0*7.0	T9	●	0.04
WEX12-17-M8-2T	WEX-A-17-M8-2T	17	8.5	26	M8	2	住友SumitomoAXMT1235***	M3.0*7.0	T9	●	0.04
WEX12-20-M10-2T	WEX-A-20-M10-2T	20	10.5	30	M10	2	住友SumitomoAXMT1235***	M3.0*7.0	T9	●	0.08
WEX12-20-M10-3T	WEX-A-20-M10-3T	20	10.5	30	M10	3	住友SumitomoAXMT1235***	M3.0*7.0	T9	●	0.08
WEX12-21-M10-3T	WEX-A-21-M10-3T	21	10.5	30	M10	3	住友SumitomoAXMT1235***	M3.0*7.0	T9	●	0.08
WEX12-25-M12-4T	WEX-A-25-M12-4T	25	12.5	35	M12	4	住友SumitomoAXMT1235***	M3.0*7.0	T9	●	0.14
WEX12-26-M12-4T	WEX-A-26-M12-4T	26	12.5	35	M12	4	住友SumitomoAXMT1235***	M3.0*7.0	T9	●	0.15
WEX12-32-M16-5T	WEX-A-32-M16-5T	32	17	40	M16	5	住友SumitomoAXMT1235***	M3.0*7.0	T9	●	0.29
WEX17-33-M16-3T	WEX-A-33-M16-3T	33	17	44	M16	3	住友SumitomoAXMT1705***	M4.0*9.0	T15	●	0.24

注Note: ●现货Spot, △交货时间短Short delivery time, ○交货时间长Long delivery time.

锁牙式铣刀头

Indexable Modular Cutter Heads

锁牙式铣刀头TEBL系列

Modular Cutter HeadTEBL Series

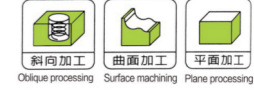
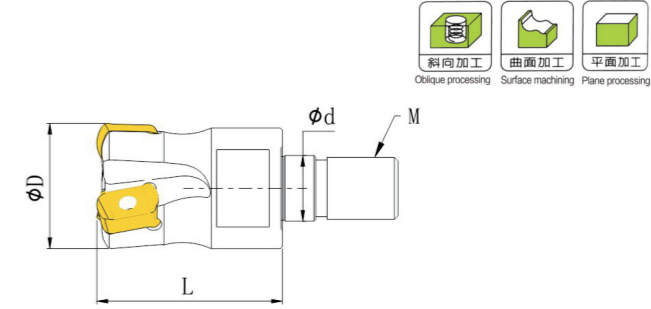

规格型号 Item code		尺寸毫米 Dimensions(mm)				刃数 Teeth	刀片规格 Insert	螺丝 Screw	扳手 Wrench	备货情况 Inventory	重量 Weight(kg)
无出水孔 No OutletHole	出水孔 Outlet Hole	D	d	L	M						
TEBL-16-M8-2T	TEBL-A-16-M8-2T	16	8.5	26	M8	2	特固克Taegu TecBLMP0603**	M2.5*6.0	T8	○	0.04
TEBL-17-M8-2T	TEBL-A-17-M8-2T	17	8.5	26	M8	2	特固克Taegu TecBLMP0603**	M2.5*6.0	T8	○	0.04
TEBL-20-M10-3T	TEBL-A-20-M10-3T	20	10.5	30	M10	3	特固克Taegu TecBLMP0603**	M2.5*6.0	T8	○	0.07
TEBL-21-M10-3T	TEBL-A-21-M10-3T	21	10.5	30	M10	3	特固克Taegu TecBLMP0603**	M2.5*6.0	T8	○	0.07
TEBL-25-M12-4T	TEBL-A-25-M12-4T	25	12.5	35	M12	4	特固克Taegu TecBLMP0603**	M2.5*6.0	T8	○	0.12
TEBL-26-M12-4T	TEBL-A-26-M12-4T	26	12.5	35	M12	4	特固克Taegu TecBLMP0603**	M2.5*6.0	T8	○	0.12
TEBL-32-M16-4T	TEBL-A-32-M16-4T	32	17	40	M16	4	特固克Taegu TecBLMP0603**	M2.5*6.0	T8	○	0.24
TEBL-32-M16-5T	TEBL-A-32-M16-5T	32	17	40	M16	5	特固克Taegu TecBLMP0603**	M2.5*6.0	T8	○	0.26
TEBL-35-M16-4T	TEBL-A-35-M16-4T	35	17	40	M16	4	特固克Taegu TecBLMP0603**	M2.5*6.0	T8	○	0.34
TEBL-35-M16-5T	TEBL-A-35-M16-5T	35	17	40	M16	5	特固克Taegu TecBLMP0603**	M2.5*6.0	T8	○	0.34
TEBL-40-M16-6T	TEBL-A-40-M16-6T	40	17	40	M16	6	特固克Taegu TecBLMP0603**	M2.5*6.0	T8	○	0.4

注Note: ●现货Spot, △交货时间短Short delivery time, ○交货时间长Long delivery time.

车削系列
Turning Series

铣削系列
Milling Series

搪系列
Fine Broing Series

车削系列
Turning Series

铣削系列
Milling Series

搪系列
Fine Broing Series

锁牙式铣刀头

Indexable Modular Cutter Heads

锁牙式铣刀头CAP系列

Modular Cutter Head CAP Series

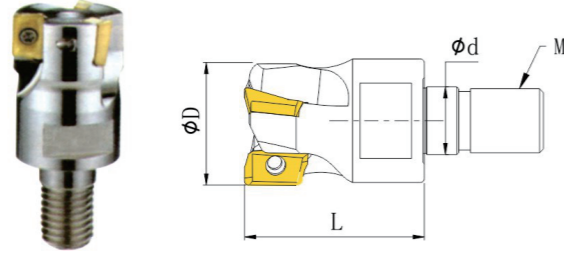

规格型号 Item code		尺寸毫米 Dimensions(mm)				刃数 Teeth	刀片规格 Insert	螺丝 Screw	扳手 Wrench	备货情况 Inventory	重量 Weight(kg)
无出水孔 No Outlet Hole	出水孔 Outlet Hole	D	d	L	M						
CAP-16-M8-2T	CAP-A-16-M8-2T	16	8.5	26	M8	2	克洛伊KorloyAPKT1003**	M2.5*6.0	T9	●	0.04
CAP-17-M8-2T	CAP-A-17-M8-2T	17	8.5	26	M8	2	克洛伊KorloyAPKT1003**	M2.5*6.0	T9	●	0.04
CAP-20-M10-2T	CAP-A-20-M10-2T	20	10.5	30	M10	2	克洛伊KorloyAPKT1003**	M2.5*6.0	T9	●	0.08
CAP-20-M10-3T	CAP-A-20-M10-3T	20	10.5	30	M10	3	克洛伊KorloyAPKT1003**	M2.5*6.0	T9	●	0.07
CAP-21-M10-2T	CAP-A-21-M10-2T	21	10.5	30	M10	2	克洛伊KorloyAPKT1003**	M2.5*6.0	T9	●	0.09
CAP-21-M10-3T	CAP-A-21-M10-3T	21	10.5	30	M10	3	克洛伊KorloyAPKT1003**	M2.5*6.0	T9	●	0.08
CAP-25-M12-3T	CAP-A-25-M12-3T	25	12.5	35	M12	3	克洛伊KorloyAPKT1003**	M2.5*6.0	T9	●	0.14
CAP-26-M12-3T	CAP-A-26-M12-3T	26	12.5	35	M12	3	克洛伊KorloyAPKT1003**	M2.5*6.0	T9	●	0.15
CAP-26-M12-4T	CAP-A-26-M12-4T	26	12.5	35	M12	4	克洛伊KorloyAPKT1003**	M2.5*6.0	T9	●	0.15

注Note: ●现货Spot, △交货时间短Short delivery time, O交货时间长Long delivery time.

锁牙式铣刀头R390系列

Modular Cutter Head R-390 Series

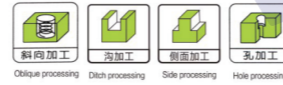
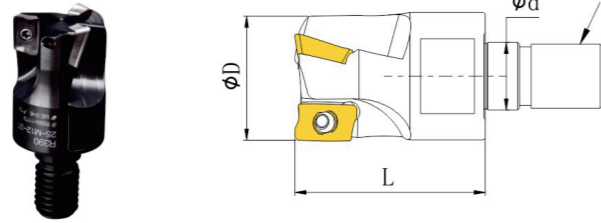

规格型号 Item code		尺寸毫米 Dimensions(mm)				刃数 Teeth	刀片规格 Insert	螺丝 Screw	扳手 Wrench	备货情况 Inventory	重量 Weight(kg)
无出水孔 No Outlet Hole	出水孔 Outlet Hole	D	d	L	M						
R39011-16-M8-2T	R39011-A-16-M8-2T	16	8.5	26	M8	2	山特维克SandvikR390-11T308	M2.5*6.0	T9	●	0.05
R39011-17-M8-2T	R39011-A-17-M8-2T	17	8.5	26	M8	2	山特维克SandvikR390-11T308	M2.5*6.0	T9	●	0.05
R39011-20-M10-2T	R39011-A-20-M10-2T	20	10.5	30	M10	2	山特维克SandvikR390-11T308	M2.5*6.0	T9	●	0.07
R39011-21-M10-2T	R39011-A-21-M10-2T	21	10.5	30	M10	2	山特维克SandvikR390-11T308	M2.5*6.0	T9	●	0.07
R39011-24-M12-3T	R39011-A-24-M12-3T	24	12.5	35	M12	3	山特维克SandvikR390-11T308	M2.5*6.0	T9	●	0.12
R39011-25-M12-3T	R39011-A-25-M12-3T	25	12.5	35	M12	3	山特维克SandvikR390-11T308	M2.5*6.0	T9	●	0.12
R39011-26-M12-3T	R39011-A-26-M12-3T	26	12.5	35	M12	3	山特维克SandvikR390-11T308	M2.5*6.0	T9	●	0.12
R39011-33-M16-4T	R39011-A-33-M16-4T	33	17	43	M16	4	山特维克SandvikR390-11T308	M3.5*9.0	T15	●	0.24
R39017-26-M12-2T	R39017-A-26-M12-2T	26	12.5	35	M12	2	山特维克SandvikR390-1704***	M3.5*7.0	T15	●	0.12
R39017-33-M16-3T	R39017-A-33-M16-3T	33	17	43	M16	3	山特维克SandvikR390-1704***	M3.5*9.0	T15	●	0.24
R39017-35-M16-3T	R39017-A-35-M16-3T	35	17	43	M16	3	山特维克SandvikR390-1704***	M3.5*9.0	T15	●	0.24

注Note: ●现货Spot, △交货时间短Short delivery time, O交货时间长Long delivery time.

锁牙式铣刀头

Indexable Modular Cutter Heads

锁牙式铣刀头AKS系列

Modular Cutter Head AKS Series

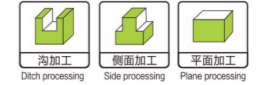
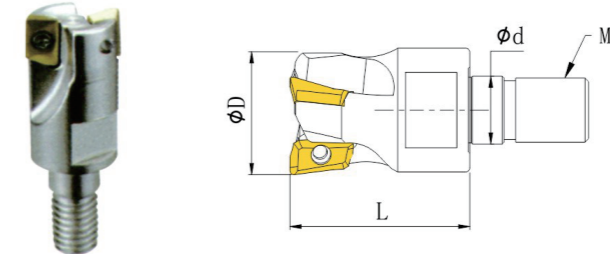

规格型号 Item code		尺寸毫米 Dimensions(mm)				刃数 Teeth	刀片规格 Insert	螺丝 Screw	扳手 Wrench	备货情况 Inventory	重量 Weight(kg)
无出水孔 No Outlet Hole	出水孔 Outlet Hole	D	d	L	M						
AKS06-10-M5-2T	AKS06-A-10-M5-2T	10	5.5	18	M5	2	森拉天时Ceratizit XOMTO602**	M1.8*4.0	T6	○	0.01
AKS06-11-M5-2T	AKS06-A-11-M5-2T	11	5.5	18	M5	2	森拉天时Ceratizit XOMTO602**	M1.8*4.0	T6	○	0.01
AKS06-12-M6-2T	AKS06-A-12-M6-2T	12	6.5	20	M6	2	森拉天时Ceratizit XOMTO602**	M1.8*4.0	T6	○	0.02
AKS06-12-M6-3T	AKS06-A-12-M6-3T	12	6.5	20	M6	3	森拉天时Ceratizit XOMTO602*	M1.8*4.0	T6	○	0.01
AKS06-13-M6-2T	AKS06-A-13-M6-2T	13	6.5	20	M6	2	森拉天时Ceratizit XOMTO602**	M1.8*4.0	T6	○	0.02
AKS06-13-M6-3T	AKS06-A-13-M6-3T	13	6.5	20	M6	3	森拉天时Ceratizit XOMTO602**	M1.8*4.0	T6	○	0.02
AKS06-16-M8-4T	AKS06-A-16-M8-4T	16	8.5	26	M8	4	森拉天时Ceratizit XOMTO602**	M1.8*4.0	T6	○	0.03
AKS06-17-M8-4T	AKS06-A-17-M8-4T	17	8.5	26	M8	4	森拉天时Ceratizit XOMTO602**	M1.8*4.0	T6	○	0.04
AKS06-20-M10-4T	AKS06-A-20-M10-4T	20	10.5	30	M10	4	森拉天时Ceratizit XOMTO602**	M1.8*4.0	T6	○	0.07
AKS06-20-M10-5T	AKS06-A-20-M10-5T	20	10.5	30	M10	5	森拉天时Ceratizit XOMTO602**	M1.8*4.0	T6	○	0.06
AKS06-25-M12-4T	AKS06-A-25-M12-4T	25	12.5	35	M12	4	森拉天时Ceratizit XOMTO602**	M1.8*4.0	T6	○	0.12
AKS06-25-M12-5T	AKS06-A-25-M12-5T	25	12.5	35	M12	5	森拉天时Ceratizit XOMTO602**	M1.8*4.0	T6	○	0.12
AKS09-16-M8-2T	AKS09-A-16-M8-2T	16	8.5	26	M8	2	森拉天时Ceratizit XOMT0903**	M2.5*6.0	T8	○	0.04
AKS09-17-M8-2T	AKS09-A-17-M8-2T	17	8.5	26	M8	2	森拉天时Ceratizit XOMT0903**	M2.5*6.0	T8	○	0.05
AKS09-20-M10-2T	AKS09-A-20-M10-2T	20	10.5	30	M10	2	森拉天时Ceratizit XOMT0903**	M2.5*6.0	T8	○	0.07
AKS09-20-M10-3T	AKS09-A-20-M10-3T	20	10.5	30	M10	3	森拉天时Ceratizit XOMT0903**	M2.5*6.0	T8	○	0.07
AKS09-21-M10-2T	AKS09-A-21-M10-2T	21	10.5	30	M10	2	森拉天时Ceratizit XOMT0903**	M2.5*6.0	T8	○	0.07
AKS09-21-M10-3T	AKS09-A-21-M10-3T	21	10.5	30	M10	3	森拉天时Ceratizit XOMT0903**	M2.5*6.0	T8	○	0.07
AKS09-25-M12-3T	AKS09-A-25-M12-3T	25	12.5	35	M12	3	森拉天时Ceratizit XOMT0903**	M2.5*6.0	T8	○	0.12
AKS09-26-M12-3T	AKS09-A-26-M12-3T	26	12.5	35	M12	3	森拉天时Ceratizit XOMT0903**	M2.5*6.0	T8	○	0.12
AKS09-26-M12-4T	AKS09-A-26-M12-4T	26	12.5	35	M12	4	森拉天时Ceratizit XOMT0903**	M2.5*6.0	T8	○	0.12
AKS09-32-M16-4T	AKS09-A-32-M16-4T	32	17	40	M16	4	森拉天时Ceratizit XOMT0903**	M2.5*6.0	T8	○	0.23
AKS09-32-M16-5T	AKS09-A-32-M16-5T	32	17	40	M16	5	森拉天时Ceratizit XOMT0903**	M2.5*6.0	T8	○	0.23
AKS09-33-M16-4T	AKS09-A-33-M16-4T	33	17	40	M16	4	森拉天时Ceratizit XOMT0903**	M2.5*6.0	T8	○	0.25
AKS09-33-M16-5T	AKS09-A-33-M16-5T	33	17	40	M16	5	森拉天时Ceratizit XOMT0903**	M2.5*6.0	T8	○	0.24

注Note: ●现货Spot, △交货时间短Short delivery time, O交货时间长Long delivery time.

车削系列
Turning Series

铣削系列
Milling Series

搪系列
Fine Broing Series

车削系列
Turning Series

铣削系列
Milling Series

搪系列
Fine Broing Series

锁牙式铣刀头

Indexable Modular Cutter Heads

锁牙式铣刀头M4系列

Modular Cutter Head M4 Series

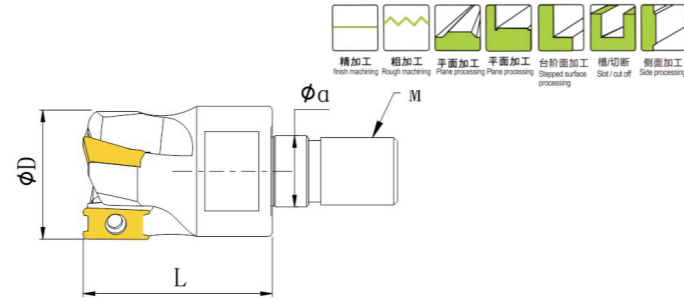

规格型号 Item code		尺寸毫米 Dimensions(mm)				刃数 Teeth	刀片规格 Insert	螺丝 Screw	扳手 Wrench	备货情况 Inventory	重量 Weight(kg)
无出水孔 No OutletHole	出水孔 Outlet Hole	D1	d	L	M						
M4-16-M8-2T	M4-A-16-M8-2T	16	8.5	26	M8	2	肯纳KennametalLNPU110408	M2.5*6.0	T8	○	0.18
M4-17-M8-2T	M4-A-17-M8-2T	17	8.5	26	M8	2	肯纳KennametalLNPU110408	M2.5*6.0	T8	○	0.18
M4-20-M10-3T	M4-A-20-M10-3T	20	10.5	30	M10	3	肯纳KennametalLNPU110408	M2.5*6.0	T8	○	0.20
M4-21-M10-3T	M4-A-21-M10-3T	21	10.5	30	M10	3	肯纳KennametalLNPU110408	M2.5*6.0	T8	○	0.20
M4-25-M12-4T	M4-A-25-M12-4T	25	12.5	35	M12	4	肯纳KennametalLNPU110408	M2.5*6.0	T8	○	0.25
M4-26-M12-4T	M4-A-26-M12-4T	26	12.5	35	M12	4	肯纳KennametalLNPU110408	M2.5*6.0	T8	○	0.25
M4-32-M16-5T	M4-A-32-M16-5T	32	17	40	M16	5	肯纳KennametalLNPU110408	M2.5*6.0	T8	○	0.32
M4-33-M16-5T	M4-A-33-M16-5T	33	17	40	M16	5	肯纳KennametalLNPU110408	M2.5*6.0	T8	○	0.35
M4-35-M16-5T	M4-A-35-M16-5T	35	17	40	M16	5	肯纳KennametalLNPU110408	M2.5*6.0	T8	○	0.35

注Note: ●现货Spot, △交货时间短Short delivery time, ○交货时间长Long delivery time.

锁牙式铣刀头VS M490系列

Modular Cutter Head VS M490 Series

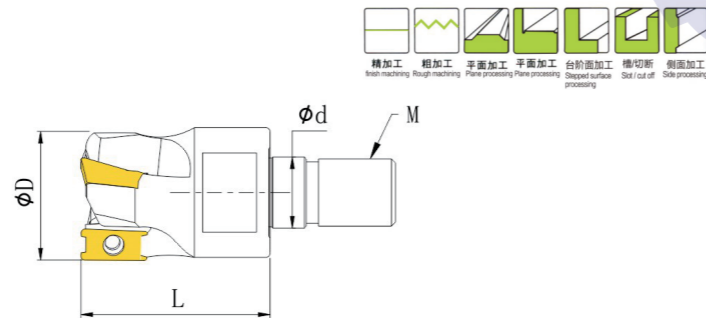

规格型号 Item code		尺寸毫米 Dimensions(mm)				刃数 Teeth	刀片规格 Insert	螺丝 Screw	扳手 Wrench	备货情况 Inventory	重量 Weight(kg)
无出水孔 No OutletHole	出水孔 Outlet Hole	D1	d	L	M						
VSM490-16-M8-1T	VSM490-A-16-M8-1T	16	8.5	26	M8	1	威迪亚WidiaXNPU100412	M2.5*6.0	T8	●	0.18
VSM490-17-M8-2T	VSM490-A-17-M8-2T	17	8.5	26	M8	2	威迪亚WidiaXNPU100412	M2.5*6.0	T8	●	0.18
VSM490-20-M10-2T	VSM490-A-20-M10-2T	20	10.5	30	M10	2	威迪亚WidiaXNPU100412	M2.5*6.0	T8	●	0.20
VSM490-21-M10-2T	VSM490-A-21-M10-2T	21	10.5	30	M10	2	威迪亚WidiaXNPU100412	M2.5*6.0	T8	●	0.20
VSM490-25-M12-3T	VSM490-A-25-M12-3T	25	12.5	35	M12	3	威迪亚WidiaXNPU100412	M2.5*6.0	T8	●	0.25
VSM490-26-M12-3T	VSM490-A-26-M12-3T	26	12.5	35	M12	3	威迪亚WidiaXNPU100412	M2.5*6.0	T8	●	0.25

注Note: ●现货Spot, △交货时间短Short delivery time, ○交货时间长Long delivery time.

锁牙式铣刀头

Indexable Modular Cutter Heads

锁牙式螺纹铣刀头XY系列

Modular type Milling Cutter Head XY series

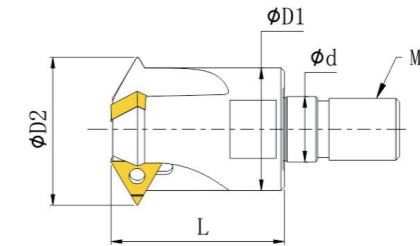

规格型号 Item code		尺寸毫米 Dimensions(mm)						刃数 Teeth	刀片规格 Insert	螺丝 Screw	扳手 Wrench	备货情况 Inventory	重量 Weight(kg)
无出水孔 No OutletHole	出水孔 Outlet Hole	D1	D2	d	L	M							
XY2U-16.75-M8-2T	XY2U-A-16.75-M8-2T	13.0	16.75	8.5	26	M8	1	2UI***	M3*7.0	T8	●	0.15	
XY2U-20.65-M8-2T	XY2U-A-20.65-M8-2T	14.1	20.65	8.5	26	M8	2	2UI***	M3*7.0	T8	●	0.18	
XY2U-22.65-M10-2T	XY2U-A-22.65-M10-2T	18	22.65	8.5	26	M10	2	2U***	M3*7.0	T8	●	0.20	
XY2U-26.6-M12-3T	XY2U-A-26.6-M12-3T	21	26.6	10.5	30	M12	3	2UI***	M3*7.0	T8	●	0.25	
XY2U-31-M12-4T	XY2U-A-31-M12-4T	25	31	12.5	25	M12	4	2UI***	M3*7.0	T8	●	0.30	
XY3U-37.15-M16-3T	XY3U-A-37.15-M16-3T	29	37.15	17	35	M16	3	3UI***	M4*9.0	T15	●	0.35	
XY3U-42.7-M16-4T	XY3U-A-42.7-M16-4T	29	42.70	17	35	M16	4	3UI***	M4*9.0	T15	●	0.40	

注Note: ●现货Spot, △交货时间短Short delivery time, ○交货时间长Long delivery time.

车削系列
Turning Series

铣削系列
Milling Series

搪系列
Fine Broing Series

车削系列
Turning Series

铣削系列
Milling Series

搪系列
Fine Broing Series

锁牙式铣刀头

Indexable Modular Cutter Heads

锁牙式正面倒角刀头SZ系列

Modular Cutter Head M4 Series

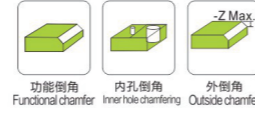
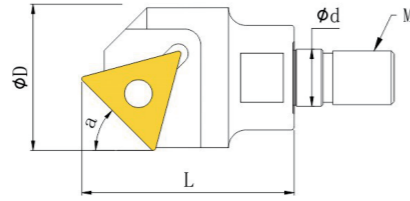

规格型号 Item code		尺寸毫米 Dimensions(mm)				刃数 Teeth	刀片规格 Insert	螺丝 Screw	扳手 Wrench	备货情况 Inventory	重量 Weight(kg)	
无出水孔 No Outlet Hole	出水孔 Outlet Hole	D1	d	L	M							a°
SZ-22-M10-1T-C45°	SZ-A-22-M10-1T-C45°	22	10.5	30	M10	45°	1	TC..16T3	M4*8	T15	●	0.25
SZ-22-M8-1T-C60°	SZ-A-22-M8-1T-C60°	22	8.5	36	M8	60°	1	TC..16T3	M4*8	T15	△	0.25
SZ-35-M12-1T-C30°	SZ-A-35-M12-1T-C30°	35	12.5	52	M12	30°	1	TC..16T3	M4*11	T15	△	0.35
SZ-35-M12-1T-C45°	SZ-A-35-M12-1T-C45°	35	12.5	52	M12	45°	1	TC..16T3	M4*11	T15	△	0.35
SZ-35-M12-1T-C60°	SZ-A-35-M12-1T-C60°	35	12.5	52	M12	60°	1	TC..16T3	M4*11	T15	△	0.35

注Note: ●现货Spot, △交货时间短Short delivery time, O交货时间长Long delivery time.

锁牙式钻铣刀头AJU系列

Modular Cutter Head AJU series

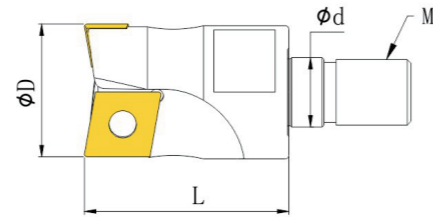

规格型号 Item code		尺寸毫米 Dimensions(mm)				刃数 Teeth	刀片规格 Insert	螺丝 Screw	扳手 Wrench	备货情况 Inventory	重量 Weight(kg)
无出水孔 No Outlet Hole	出水孔 Outlet Hole	D	d	L	M						
AJU-16-M8-2T	AJU-A-16-M8-2T	16	8.5	26	M8	2	日立Hitachi	M2.5*6.0	T8	●	0.04
AJU-20-M10-2T	AJU-A-20-M10-2T	20	10.5	30	M10	2	日立Hitachi CPMT090204ZCCMTO60204	M2.5*6.0/M3.5*7.0	T8	●	0.08
AJU-25-M12-2T	AJU-A-25-M12-2T	25	12.5	35	M12	2	日立Hitachi CPMT120308ZCPMT090308	M3.5*7.0/M4.0*9.0	T15	●	0.13
AJU-32-M16-2T	AJU-A-32-M16-2T	32	17	35	M16	2	日立Hitachi CPMT120408CPMT160408Z	M4*10/M5*11	T15		

注Note: ●现货Spot, △交货时间短Short delivery time, O交货时间长Long delivery time.

车削系列
Turning Series

铣削系列
Milling Series

搪系列
Fine Broing Series

车削系列
Turning Series

铣削系列
Milling Series

搪系列
Fine Broing Series

