

Introduction of Ti(C,N)-based Cermet

Ti(C,N) 基金属陶瓷介绍

Cermet Grades

金属陶瓷牌号

定义及特征 / Definition

Ti(C,N)基金属陶瓷是一种由陶瓷硬质相(碳氮化钛)与金属粘结相(Mo,Ni)组成的复合材料,它既具有陶瓷材料的高硬度、高耐磨、耐腐蚀以及抗高温氧化的性能特点,同时还兼具金属材料较好的韧性。

Ti(C,N)-based cermet is a kind of composite material consisting of ceramic particles bonded with a metal binder phase, which combines the favorable properties of ceramics (high hardness and wear, corrosion and high-temperature oxidation resistance) with those of metals (toughness especially).

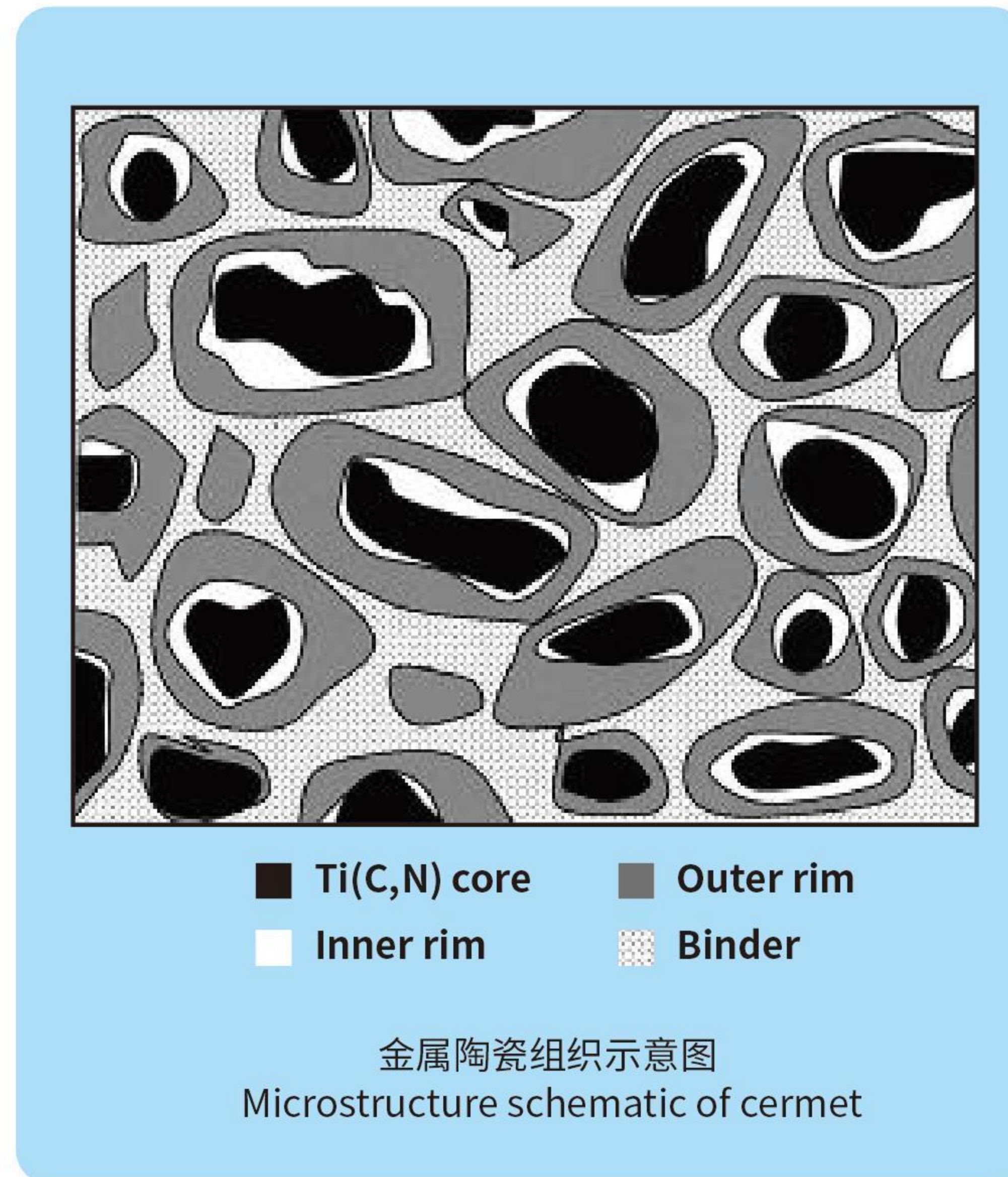

应用领域 / Application area

Ti(C,N)基金属陶瓷独特的理化性能可使其广泛用作数控刀具、3C模具、各类高温耐磨零部件以及电缆和化纤行业用特殊切断刀等。

The unique physical and chemical properties of Ti(C,N)-based cermets makes it a promising material for cutting tools, 3C molds, high temperature wear-resistant parts and special cutting blades for cables and chemical fibers, etc.



ST20

牌号Grade	ST20	特征 Feature	密度低、强韧性好,红硬性高,化学稳定性好,同时还具有优异的高温抗氧化性能,切削加工过程中不易产生积屑瘤。 It has low density, high strength, high hot hardness, good chemical stability and excellent high temperature oxidation resistance. It is hard to form built-up edge in cutting process.
密度Density	6.20 g/cm ³	用途 Applications	适用于碳钢、合金钢、铸铁、不锈钢和钛合金等难加工材料的高速精加工和半精加工,被加工工件表面非常光洁、平整。 Suitable for high speed finishing and semi-finishing of carbon steel, alloy steel, cast iron, stainless steel, titanium alloy and other difficult-to-machine materials with excellent surface finish.
硬度Hardness	92.0 HRA	显微组织 Microstructure	
抗弯强度T.R.S	3000 MPa		
断裂韧性K _{IC}	9.8MPa·m ^{1/2}		
孔隙度Porosity	A02		
	B00		
	C00		

ST25

牌号Grade	ST25	特征 Feature	具有优异的高温抗氧化性、耐腐蚀性和抗热震性能,在循环热冲击作用下可长久保持较好的尺寸稳定性。It has excellent high temperature oxidation resistance, corrosion resistance and thermal shock resistance, and can maintain good dimensional stability under cyclic thermal shock for a long time.
密度Density	6.90 g/cm ³	用途 Applications	3D玻璃热弯机用均热板及其他领域高温模具 Heating transfer plate of 3D glass hot bending machine and other high-temperature molds.
硬度Hardness	87.0 HRA	显微组织 Microstructure	
抗弯强度T.R.S	2300 MPa		
800°C热导率 Thermal conductivity	30 W·m ⁻¹ ·K ⁻¹		
400-800°C热膨胀系数 coefficient of thermal expansion	9.0 x 10 ⁻⁶ /°C		
800°C比热容 Specific heat capacity	510 J·kg ⁻¹ ·°C ⁻¹		
800°C氧化增重 Oxidation increment	0.02 mg·cm ⁻² ·h ⁻¹		

ST30

牌号Grade	ST30	特征 Feature	兼具高韧性和高耐磨性,同时还拥有优异的耐腐蚀性能。 A grade with both high fracture toughness and good wear resistance, as well as excellent corrosion resistance.
密度Density	6.60 g/cm ³	用途 Applications	适用于腐蚀性环境下对强韧性要求较高的工况,如电力、石化、机械、纺织、造纸等行业用切刀、密封件等。 Suitable for corrosive environment with high requirement of strength and toughness, such as cutting knives, seals for electric power, petrochemical, machinery, textile and paper industries, etc.
硬度Hardness	88.0 HRA	显微组织 Microstructure	
抗弯强度T.R.S	2800 MPa		
断裂韧性K _{IC}	18 MPa·m ^{1/2}		
孔隙度Porosity	A02		
	B00		
	C00		

Cermet Rods

金属陶瓷棒材

ST41

牌号Grade	ST41	特征 Feature	硬度高、强韧性好，硬质相组织细小均匀，可加工出十分锋利的刃口，耐磨性好，使用过程中不易磨损。 High hardness, good strength and toughness, fine and uniform hard phase organization, can be processed into a very sharp edge, good wear resistance, not easy to wear during use.
密度Density	6.80 g/cm ³		
硬度Hardness	92.5 HRA	用途 Applications	适用于硬度45HRC以内的碳钢、合金钢、铸铁以及不锈钢等材料的高速精加工和半精加工，被加工工件表面可达镜面。 It is suitable for high-speed finishing and semi-finishing of carbon steel, alloy steel, cast iron and stainless steel materials within 45HRC hardness, and the surface of the machined workpiece can reach the mirror surface.
抗弯强度T.R.S	3000 MPa		
断裂韧性K _{IC}	8.5MPa·m ^{1/2}	显微组织 Microstructure	
孔隙度Porosity	A02		
	B00		
	C00		

ST45

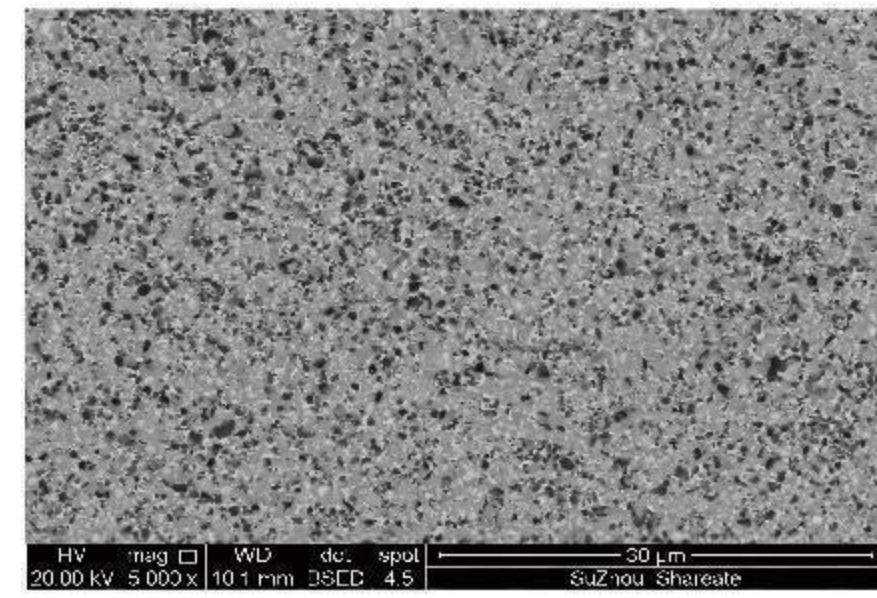
牌号Grade	ST45	特征 Feature	强韧性好，硬度适中，高温红硬性和化学稳定性优异，同时还具有较好的抗冲击性能，可应用于部分断续加工工况。 Good strength and toughness, moderate hardness, high temperature red hardness and chemical stability, but also has good impact resistance, can be applied to part of the intermittent processing conditions.
密度Density	7.25 g/cm ³		
硬度Hardness	91.5 HRA	用途 Applications	适用于硬度40HRC以内的碳钢、低合金钢、铸铁和轴承钢等材料的精加工和半精加工，尤其适合高速切削和大余量加工。 It is suitable for finishing and semi-finishing of carbon steel, low alloy steel, cast iron and bearing steel with hardness less than 40HRC, especially for high-speed cutting and large margin machining.
抗弯强度T.R.S	3000 MPa		
断裂韧性K _{IC}	9.0 MPa·m ^{1/2}	显微组织 Microstructure	
孔隙度Porosity	A02		
	B00		
	C00		

产品描述 / Product Description

ST20牌号是一款全新的高氮无钴Ti(C,N)基金属陶瓷材质，不仅具有较高的强韧性和耐磨性，而且高温抗塑性变形能力强，用作切削刀具时与工件间的摩擦系数低，被加工工件表面光洁度高，综合性能优于国内外同类金属陶瓷和常用硬质合金，刀具使用寿命明显更长。

ST20 is a new cobalt-free cermet grade with high nitrogen content. It is not only has high strength, toughness and good wear resistance, but also shows superior thermal deformation resistance at high temperatures. When used as a cutting tool, the friction coefficient between cermet and workpieces is low and result in excellent surface finish. The comprehensive performance of Shareate ST20 is better than that of other cermets and cemented carbides and has a much longer tool life.



规格尺寸 / Size

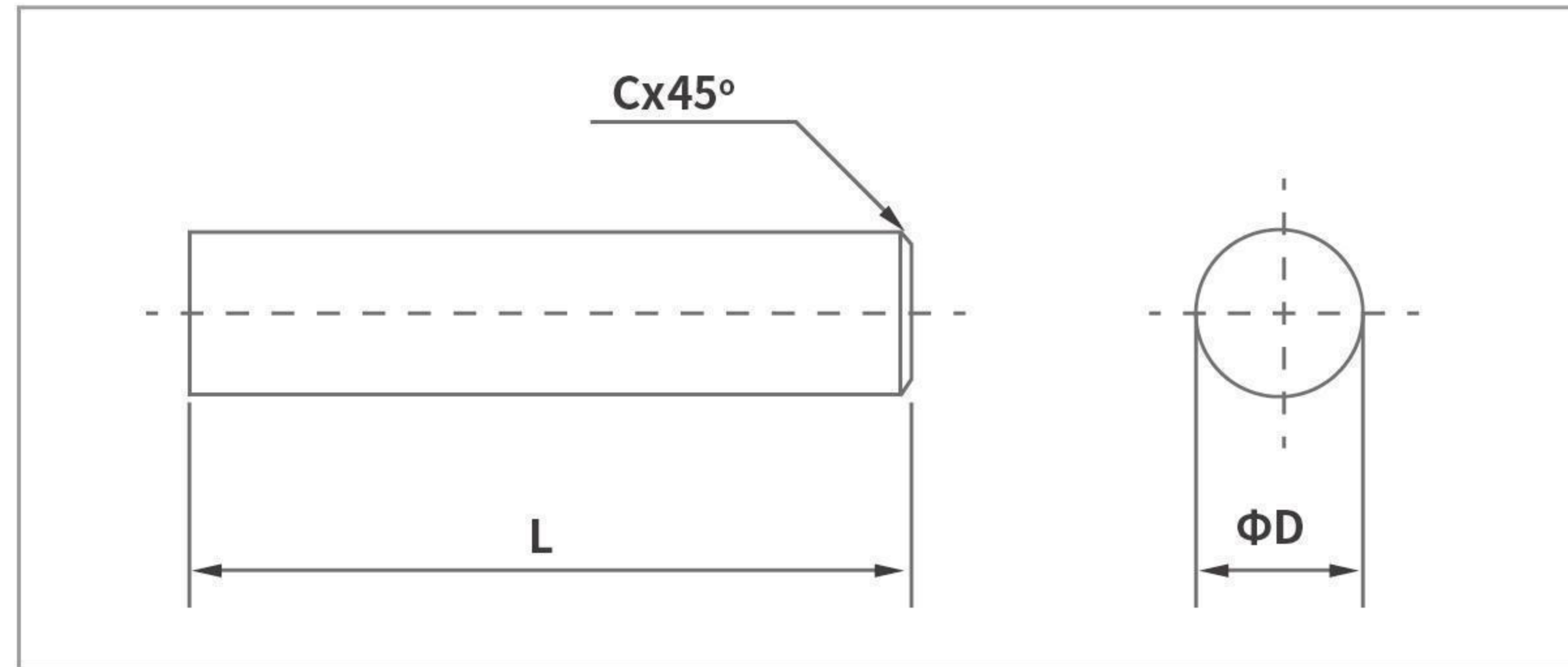

根据客户需求提供金属陶瓷定常毛坯或精磨棒料, 常规尺寸如下:

Shareate can provide different sizes of rough or grinding rods according to customers' requirements. The standard sizes included below:

单位Unit:mm

尺寸 Size			直径精度 Diameter precision	
直径(ΦD)	长度(L) (公差Tol.+0.5/+1.0)	精磨倒角尺寸 Grinding chamfer size(C) (公差Tol.±0.1)	毛坯 Rough	精磨 Grinding
3	0~150	0.3	+0.3/+0.5	h6
4	0~150	0.4	+0.3/+0.5	
6	0~150	0.4	+0.3/+0.6	
7	0~150	0.5	+0.3/+0.6	
8	0~150	0.6	+0.3/+0.6	
10	0~150	0.6	+0.3/+0.6	
12	0~150	0.8	+0.3/+0.6	
14	0~150	0.8	+0.3/+0.7	
16	0~150	0.8	+0.3/+0.7	
18	0~150	0.8	+0.3/+0.7	
20	0~150	1.0	+0.3/+0.7	

注:棒料牌号:ST41和ST20。

Cermet Heating Transfer Plate

金属陶瓷均热板

产品描述 / Product Description

ST25牌号金属陶瓷均热板是专门针对3D玻璃热弯机高温成型作业所开发的一款全新材质。相对于传统钨钢材质均热板,金属陶瓷均热板具有更高的硬度和极优异的高温抗氧化性能,在高温热压工况下温度偏差小,导热更加均匀,并且只有微变形量(0.02-0.03mm),使用寿命明显延长。

ST25 Cermet heating transfer plate is a brand-new grade specially developed for 3D glass hot bending machine. It has much higher hardness and excellent high-temperature oxidation resistance when compared with other tungsten carbide. During the high temperature hot pressing operation, the temperature deviation of Cermet heating transfer plate is small, heat conduction is more uniform and the deformation is also small (0.02-0.03mm). Therefore, the service life of Shareate ST25 is obviously longer than other traditional heating transfer plates.

◆ ST25与传统均热板性能对比

Comparison between ST25 and other traditional normal heating transfer plate

牌号 Grade	密度 (g/cm ³)	硬度 (HRA)	抗弯强度 (MPa)	800°C热导率 (W·m ⁻¹ ·K ⁻¹)	400-800°C 热膨胀系数 (X10 ⁻⁶ /°C)	800°C比热容 (J·kg ⁻¹ ·°C ⁻¹)
ST25	6.9	87.0	2300	30	9.0	510
YG6合金	14.8	89.5	1450	32	4.6	210
310S	7.9	71.5	900	18	16	530
SiC陶瓷	3.2	86.0	600	40	5.0	230

◆ ST25与钨钢均热板高温抗氧化实验

High temperature oxidation test of ST25 cermet and cemented carbide plates

材质 Material	硬质合金 Cemented Carbide		金属陶瓷 Cermet	
试验条件 Test conditions	空气环境下加热到850°C保温24h Heating in the air condition of 850°C for 24h.			
形貌 Appearance	常温	850°C	常温	850°C
氧化增量Weight gain (mgcm ⁻² h ⁻¹)	0	10.12	0	0.02
结果 Test results	氧化严重, 体积明显膨胀并向各方向剥落 Oxidized seriously, and expanded in all directions or even peeled off.		基本无明显变化 Without obvious surface change.	

Cermet Digital Cuttings

金属陶瓷数控刀片

规格尺寸 / Size

金属陶瓷均热板的尺寸可根据3D玻璃热弯机设备厂商的要求定制生产, 目前常规尺寸主要如下:

The size of Cermet heating transfer plate can be customized according to the specification of 3D glass hot bending mould, the standard sizes included below:

单位 Unit:mm

长度(L)	宽度(W)	高度(H)
200	125	12
200	130	12
200	135	12
200	138	12
200	146	12
100	70	10
100	78	10

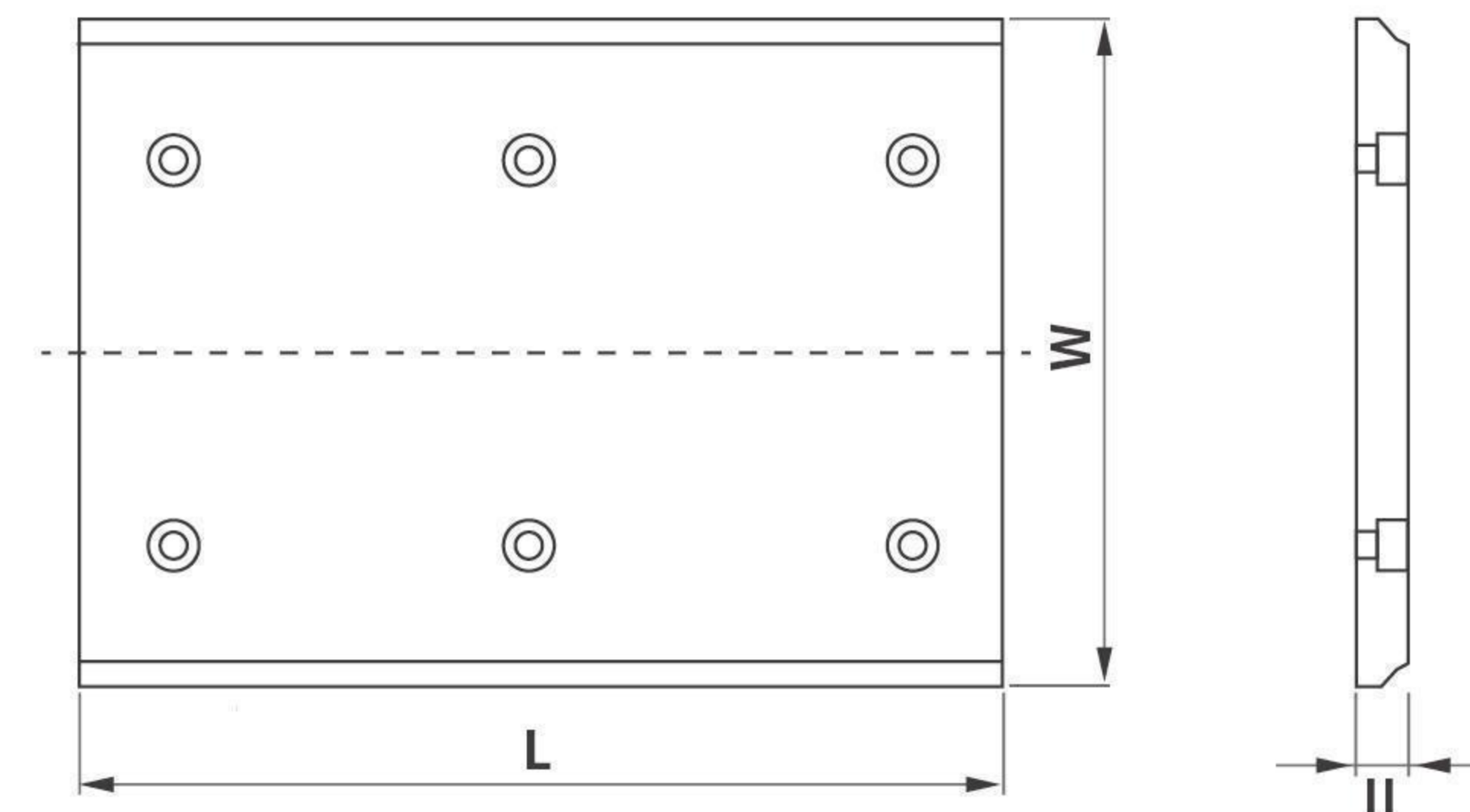

还可按照图纸尺寸加工定位孔和提供工作面抛光处理。
Also can provide final products with location holes and polished surfaces.

产品展示 / Production Display

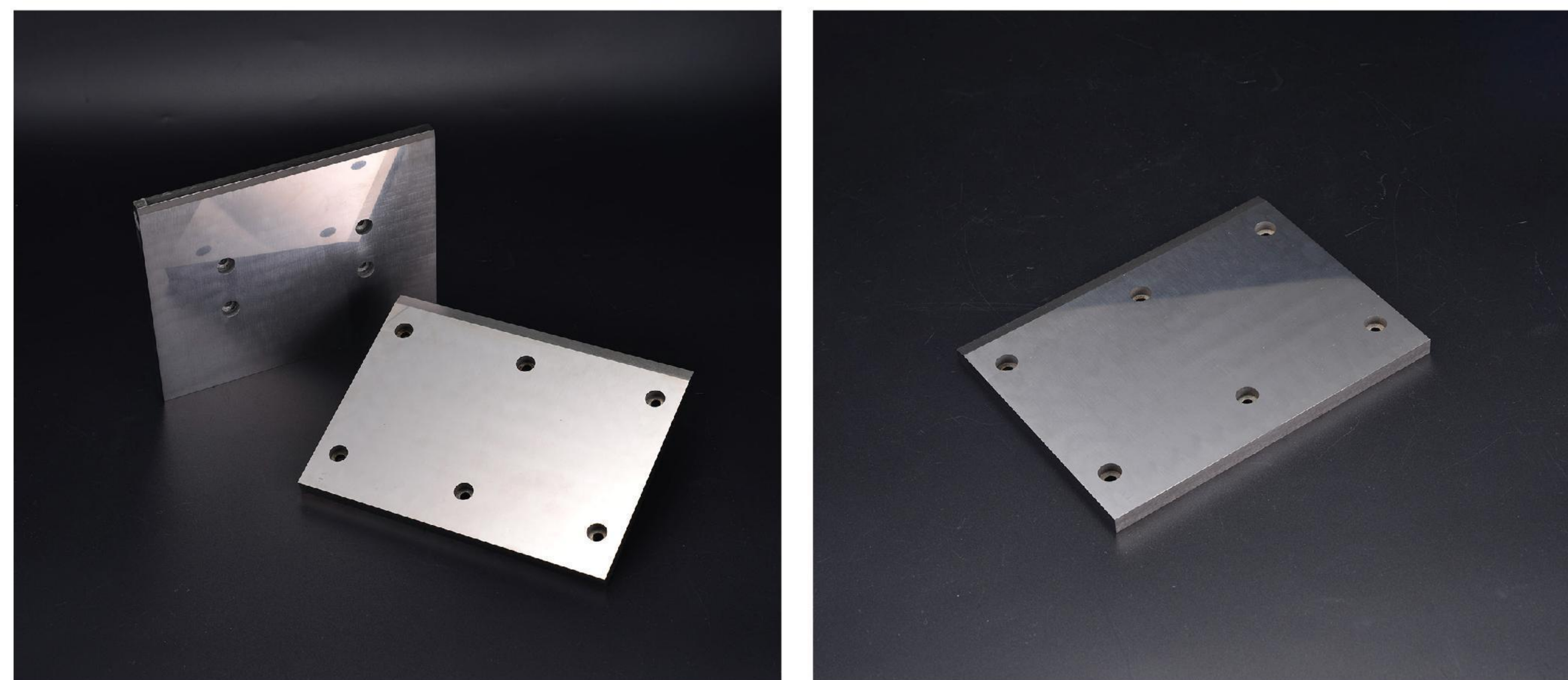











产品描述 / Product Description

ST41牌号的是Ti(C,N)基金属陶瓷材质, 适用于硬度低于HRC40的碳钢、低合金钢、不锈钢、铝合金等材料的精加工、半精加工, 连续车削、铣削和开槽加工。尤其擅长铝合金的高精表面加工。高耐磨性, 高表面光洁度, 高切削效率。

ST41 is used as a cutting tool suitable for finishing, semi-finishing, continuous turning, milling and slotting of carbon steel, low alloy steel, stainless steel, aluminum alloy and other materials whose hardness is lower than HRC40. High precision surface finishing at aluminum alloy. A grade with both high wear resistance and high surface finish, as well as high cutting efficiency.

规格尺寸 / Size

外观	型号	尺寸 (mm)			牌号		
		内切圆(I.C)	厚度(S)	刀尖圆弧半径(Re)	ST20	ST41	ST45
	CCMT060204-MT	6.35	2.38	0.4	●	●	●
	CCMT09T304-MT	9.525	3.97	0.4	●	●	●
	CCMT060204-HQ	6.35	2.38	0.4	●	●	●
	CCMT09T304-HQ	9.525	3.97	0.4	●	●	●
	CCMT09T304-FG	9.525	3.97	0.4	●	●	●
	CNMG120404-MT	12.70	4.76	0.4	●	●	●
	CNMG120404-HQ	12.70	4.76	0.4	●	●	●
	CNMG120408-HQ	12.70	4.76	0.8	●	●	●
	DCMT070204-FG	6.35	2.38	0.4	●	●	●
	DCMT11T304-FG	9.525	3.97	0.4	●	●	●
	DCMT070204-HQ	6.35	2.38	0.4	●	●	●
	DCMT11T304-HQ	9.525	3.97	0.4	●	●	●
	DNMG150404R-FS	12.70	4.76	0.4	●	●	●

	DNMG150404R-HQ	12.70	4.76	0.4	•	•	•
	DNMG150404R-VF	12.70	4.76	0.4	•	•	•
	RPMT120300	12.00	3.18		•	•	•
	RPMT160400	16.00	4.76		•	•	•
	SNMG120404-HQ	12.70	4.76	0.4	•	•	•
	TCMT110204-MT	6.35	2.38	0.4	•	•	•
	TNMG160404-MT	9.525	4.76	0.4	•	•	•
	TNMG160404R-FS	9.525	4.76	0.4	•	•	•
	TNMG160404-HQ	9.525	4.76	0.4	•	•	•
	TNMG160408-HQ	9.525	4.76	0.8	•	•	•
	TNMG160404R-VF	9.525	4.76	0.4	•	•	•
	TNMG160404L-VF	9.525	4.76	0.4	•	•	•
	TNMG160408R-VF	9.525	4.76	0.8	•	•	•
	VNMG160404-MT	9.525	4.76	0.4	•	•	•
	VNMG160404-HQ	9.525	4.76	0.4	•	•	•
	WNMG080404-HQ	12.70	4.76	0.4	•	•	•
	WNMG080408-HQ	12.70	4.76	0.8	•	•	•
	WNMG080404-MT	12.70	4.76	0.4	•	•	•
	WNMG080408-MT	12.70	4.76	0.8	•	•	•
	WNMG080408	12.70	4.76	0.8	•	•	•
	WNMG080408-TSF	12.70	4.76	0.8	•	•	•
	WNMG080404-TS	12.70	4.76	0.4	•	•	•

Cermet Cutting Tools for Machining Bearings

金属陶瓷轴承刀

产品描述 / Product Description

ST45牌号的Ti(C,N)基金属陶瓷材质兼具较高抗弯强度、硬度和断裂韧性,是一款适合于耐冲击工况的理想材料,可以应用于加工轴承等领域。

ST45 grade has high flexural strength, hardness and fracture toughness. It is an ideal material suitable for impact resistance, and can be used in machining bearing and other fields.

规格尺寸 / Size

外观	型号	尺寸(mm) Size			牌号Grade		
		内切圆(I.C)	厚度(S)	刀尖圆弧半径(Re)	ST20	ST41	ST45
	SNMN090308	9.525	3.18	0.4	•	•	•
	SNMN120408	12.70	4.76	0.8	•	•	•
	SNMN150408	15.875	4.76	0.8	•	•	•
	TNMN220408	12.70	4.76	0.8	•	•	•
	TNMN270408	15.875	4.76	0.8	•	•	•

外观	型号	尺寸(mm) Size				牌号Grade		
		角度	L	B	S	ST20	ST41	ST45
	F8	120°	21.5	8.2	6.9	•		•
	F10	120°	21.5	10.2	7.8	•		•
	F12B	120°	26.5	12.2	8.0	•		•
	F15	120°	32	15.2	10.2	•		•
	F16	120°	32	16.2	10.2	•		•
	F20	120°	36.5	20.2	11.1	•		•

Non-standard Cermet Products

金属陶瓷异型件

产品描述 / Product Description

ST30牌号的Ti(C,N)基金属陶瓷材质兼具较高抗弯强度、硬度和断裂韧性,同时还拥有极好的耐腐蚀性能,是一款适合于耐冲击和耐腐蚀工况的理想材料,可以广泛应用于电缆切刀、化纤切刀及各类耐磨零件等异型产品。

ST30 Ti(C,N) based cermet grade has high transverse rupture strength, hardness and fracture toughness, as well as excellent corrosion resistance. It is an ideal material for impact-corrosion working condition, which can be widely used as cable cutting tools, chemical fiber cutting tools, various abrasion resistant parts and other non-standard products.

ST30与传统含钴金属陶瓷耐冲蚀腐蚀实验表面形貌 / Erosion-corrosion resistance tests of ST30 and cobalt-containing cermet .

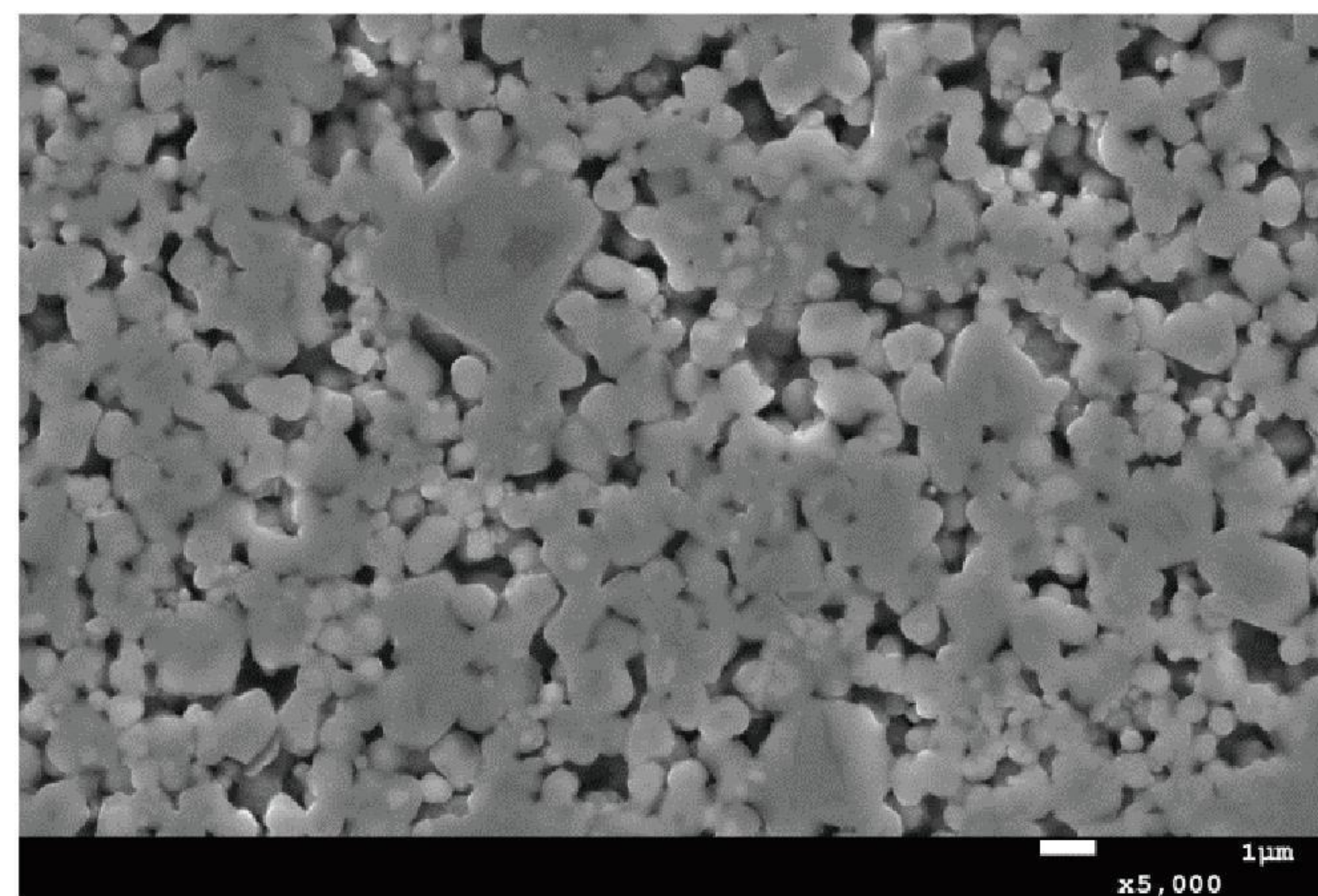

ST30 Cobalt-free cermet

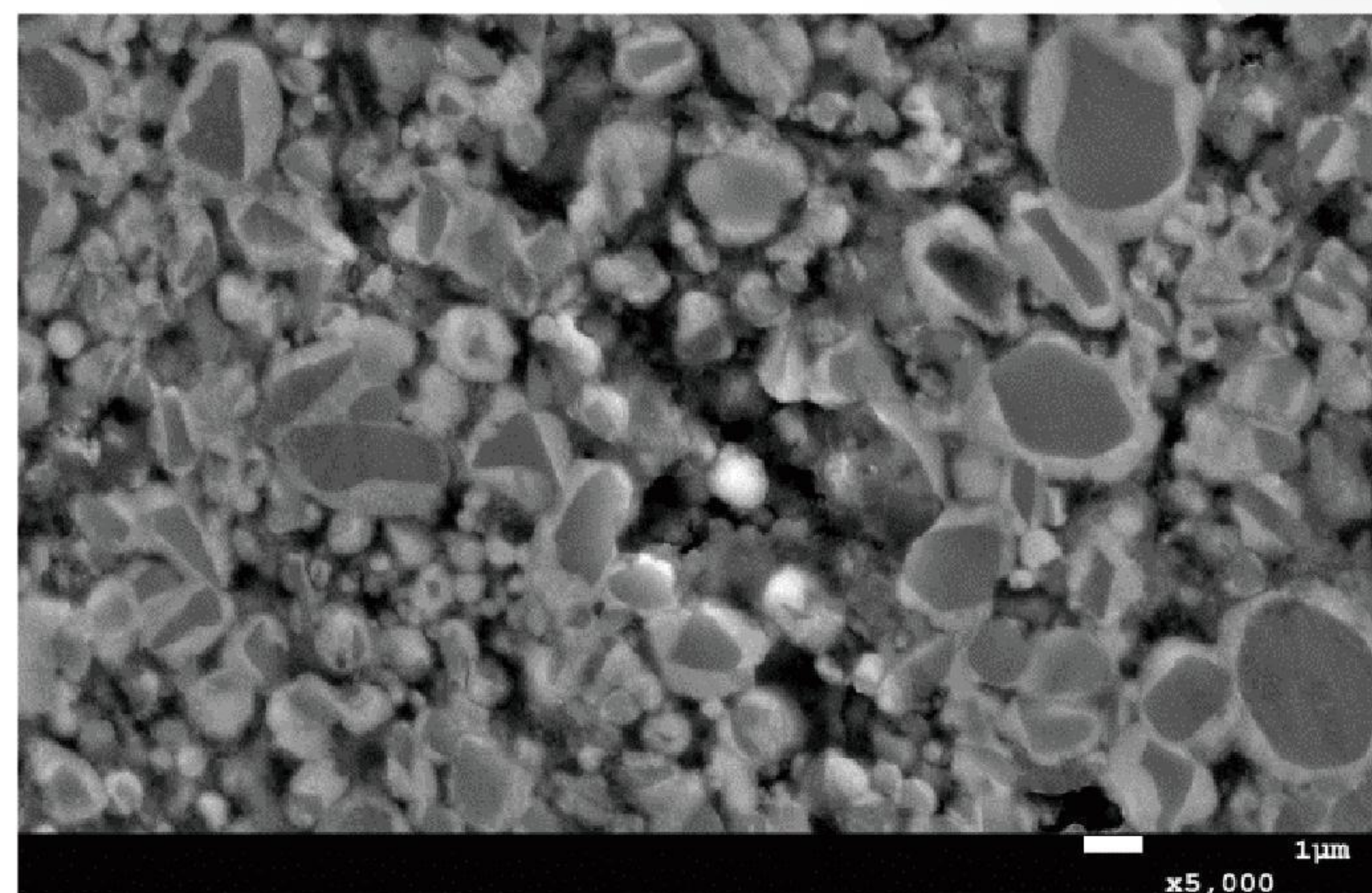

含钴金属陶瓷Cobalt-containing cermet

产品展示 / Production display

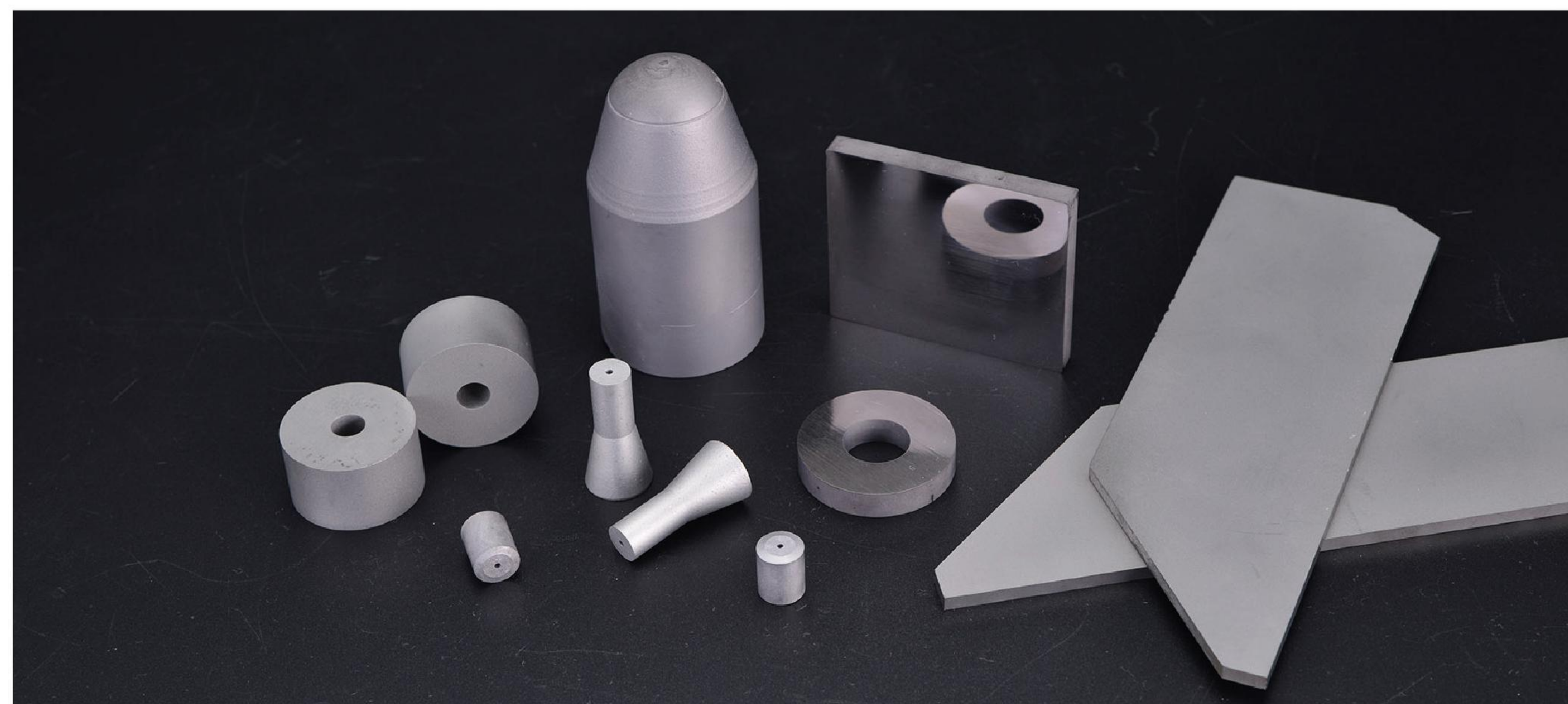

金属陶瓷非标定制 / Non-standard Customize Service

We have a strong capability of new product development, our knowledge and technology of cermet material derived from many years' research and application, and willing to cooperate with customers to manufacture reliable cermet products suitable for different working conditions.

金属陶瓷注意事项 / Notes

- ◆ 金属陶瓷在后加工过程中要充分冷却,避免因冷却不到位导致材料热量集中出现热裂纹;
- ◆ 金属陶瓷在切削应用中建议干切或风冷;
- ◆ 金属陶瓷加工参数同常规硬质合金材质差异较大,具体可咨询我司工程师。
- ◆ Cermet should be fully cooled during post-processing to avoid thermal cracks;
- ◆ Cermet are recommended for dry cutting or air cooling in cutting applications;
- ◆ The processing parameters of cermet are quite different to carbide materials, for more details please call our engineers.