



specialized in production of high-end diamond and boron nitride wheel. We have a customer service team of highly trained engineers to optimise grinding techniques . And we continues to strive towards excellence in providing the very best customer satisfaction through product innovation and improvements.

### PROFESSIONAL GRINDING EXPERT

Tool and Cutter grinding wheels

CNC Insert grinding wheels

Polishing Slurry & grinding wheels  
( sapphire/ ceramic / magnetic material)

Surface and OD grinding wheels



intelligent Manufacturing will help improve the world

用心产品 创新世界

## OUR SERVICES FOR THE BELOW MATERIALS PROCESSING AT A GLANCE

### **Tungsten steel**

*eg. Tool , Cutter, Saws*

### **HSS / Stainless Steel**

*eg. Tool , Cutter , Piston ring*

### **Cermet**

*eg. Tool and Cutter etc.*

### **Optical Glass**

*eg. Sapphire, Precision Optics*

### **Others**

*eg. silicon wafer etc.*



Intelligent Manufacturing will help improve the world

用心产品 创新世界

## Application

Grinding of TC and HSS cutting tools

HYW offers a leading solution for high-performance grinding of tungsten carbide and HSS cutting tools. The excellent cutting performance and the cost-efficient polishing optimises your grinding process.



Customer-specific wheel designs available on request.

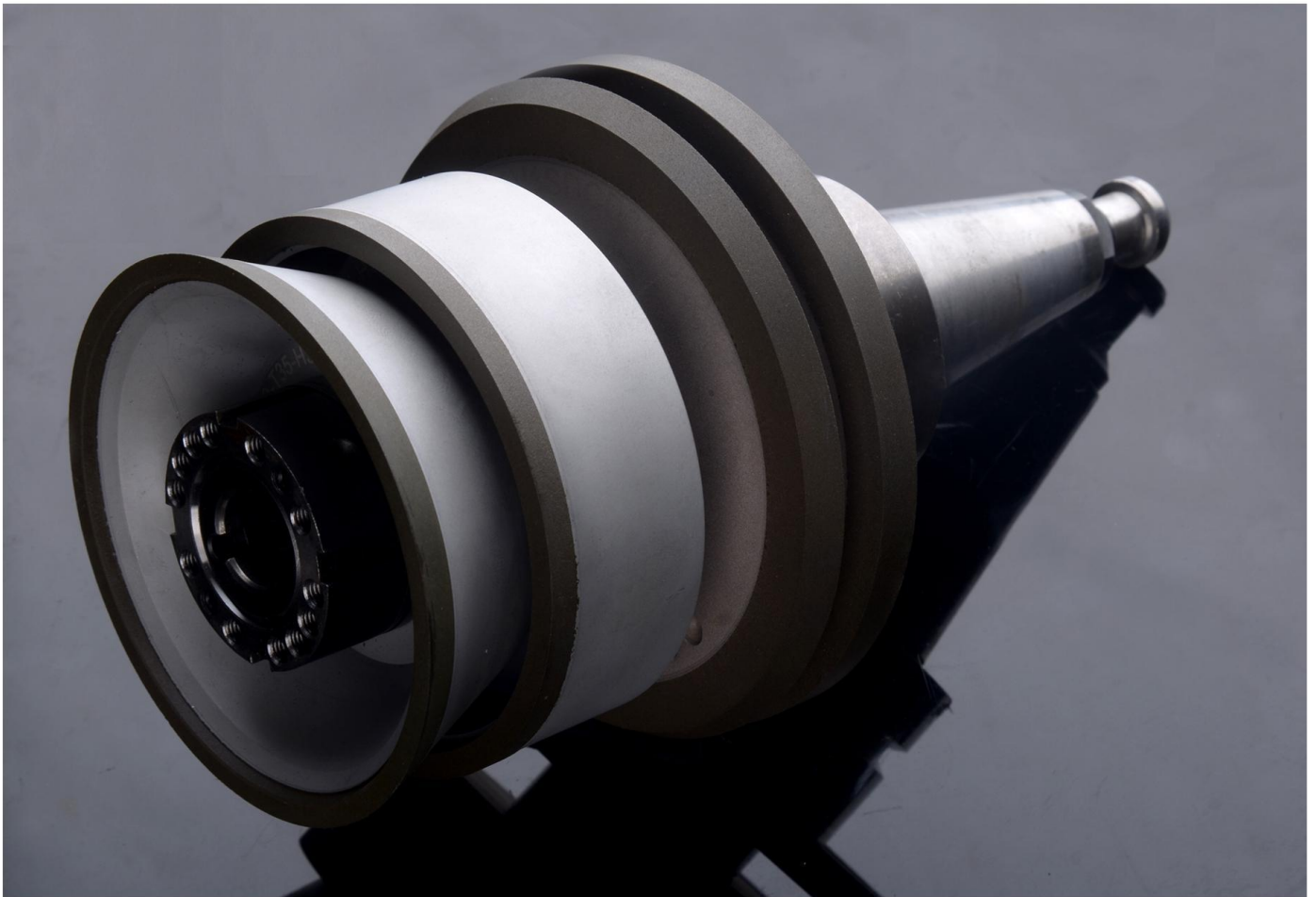



Intelligent Manufacturing will help improve the world

用心产品 创新世界



## INSERT GRINDING WHEELS

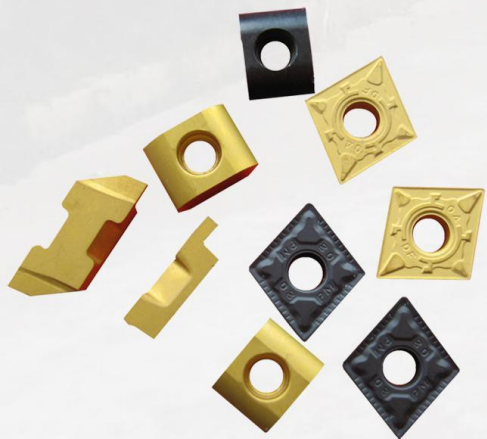

### **Workpiece material:**

Cemented carbide ,Cermet and Ceramic ,etc.

### **Features:**

High precision & Efficient grinding  
Reduced chipping ,Excellent surface finish  
Excellent grinding ratio & Cost reduction  
Short cycle time / Long tool life

### **Grinders**

Wendt, EWAG, Agathon, etc.

Intelligent Manufacturing will help improve the world

用心产品 创新世界

## Surface / OD grinding Wheel

Centerless Grinding Wheels

Segment Deviation Grinding Wheels

Grinding Wheels for piston ring / Compressors

Indexable inserts Grinding Wheels

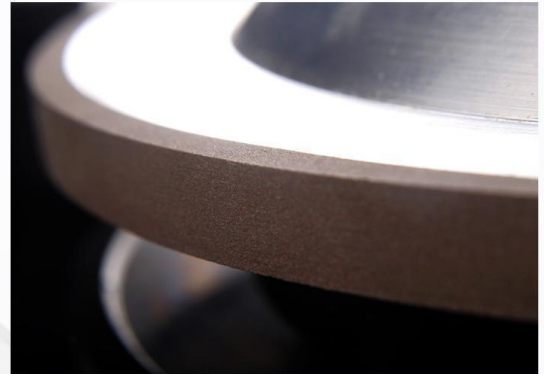

### Cost reduction:

Excellent grinding ratio

### Easy to profile :

Due to the new bond, the grinding wheel can be trued in the shortest possible time.

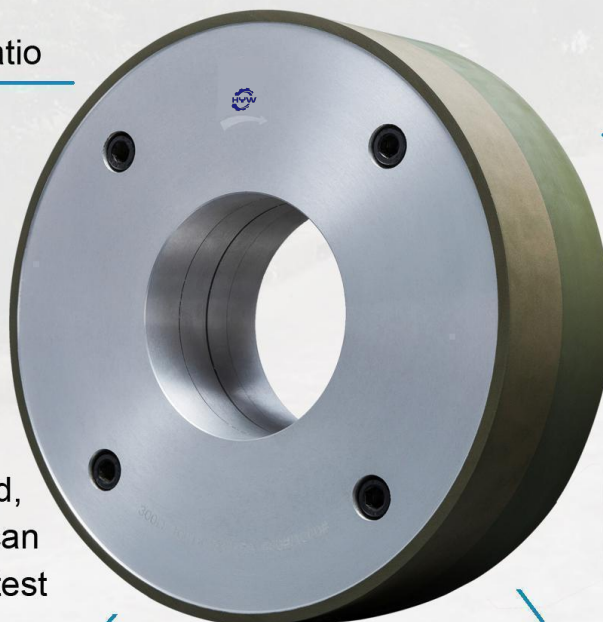

### Optimum edge retention:

The special combination of bond, diamond quality and grit size extends the dressing interval and guarantees consistently high tool quality

### Shorter grinding times:

The optimum combination of the double grit to the new product line delivers higher stock removal rates and shorter grinding cycles.



Intelligent Manufacturing will help improve the world

用心产品 创新世界

## Grit Size

For optimum stock removal capability it is generally of advantage to use the largest grit size allowing surface quality requirements.

- If the infeed speed is fast, the depth of cut should be shallow
- If the infeed speed is small, the depth of cut should be deep.

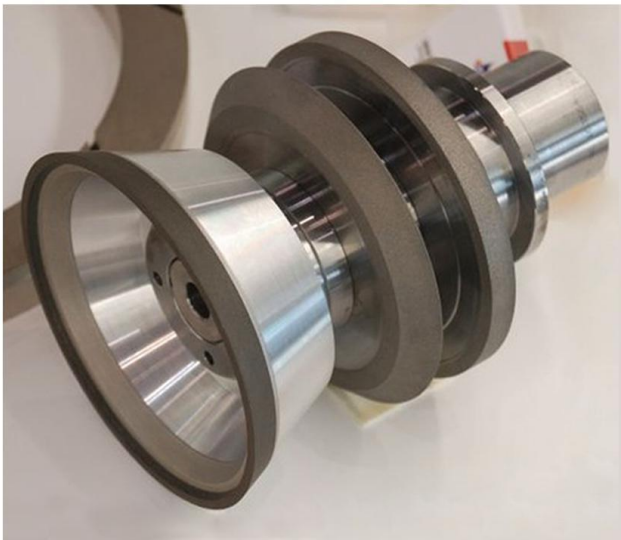

CHINA&USA Standard	FEPA Standard
70/80	D181
80/100	D151
120/140	D126
140/170	D107
170/200	D91
200/230	D76
230/270	D64
270/325	D54
325/400	D46
400/500	D40
500	D35
600	D30
800	D25
1000	D15C
1200	D15B
1500	D15A
2000	D10
3000	D7
5000	D5
8000	D3

## How to order Wheels

Please inform us of the following information when you place an order

- 1/ Shape and Size of the wheel
- 2/ Details of the wheel (*Abrasive type / Grit size / Concentration / Bond*)
- 3/ Quantity and Delivery date
- 4/ Wheels can be customized if additional information is provided
  - a、 Workpiece  
*Material / Machining allowance / Surface roughness / Dimensional accuracy*
  - b、 Machining Method  
*Cylindrical grinding / Surface grinding / Form grinding, etc.*
  - c、 Machining Conditions  
*Machine used - Manufacturer / Model /Horsepower / wheel peripheral speed / Work speed / Depth of cut / Cycle time / Cutting fluid*

Intelligent Manufacturing will help improve the world

用心产品 创新世界

■ Example: 6A2C

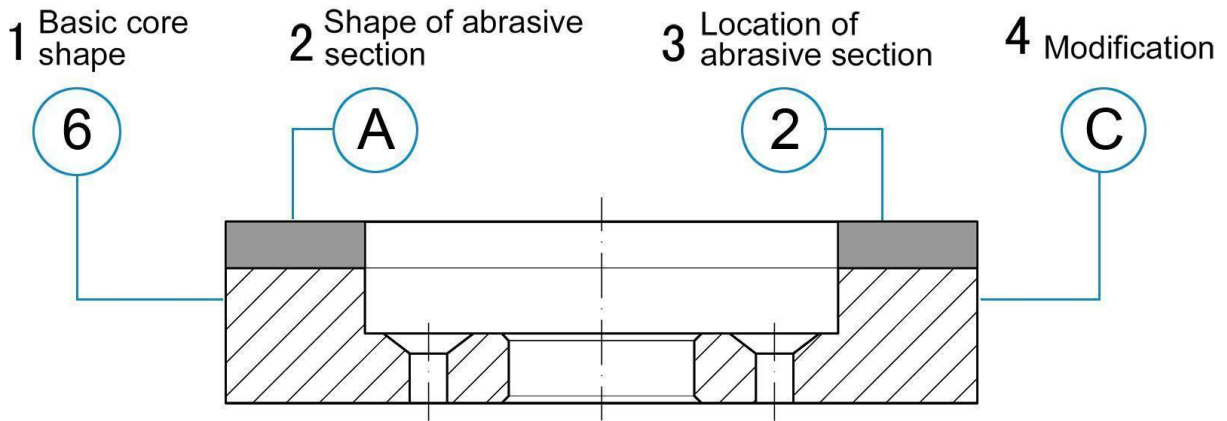

1 Basic core shapes

Symbol	Shape
1	
2	
3	
4	
6	
9	
11	
12	
14	
15	

2 Shapes of abrasive cross section

Symbol	Shape	Symbol	Shape	Symbol	Shape
A		EE		LL	
AH		ET		M	
B		F		P	
BT		FF		Q	
C		G		QQ	
CH		GN		R	
D		H		S	
DD		J		U	
E		K		V	
ER		L		Y	

Intelligent Manufacturing will help improve the world

用心产品 创新世界

### 3 Locations of abrasive section

Symbol	Location	Shape	Symbol	Location	Shape
1	Periphery		5	Outside bevel or Arc	
			6	Part of periphery	
2	Side		7	Part of Side	
			8	Throughout	
3	Sides		9	Corner	
4	Inside bevel or Arc		10	Annular	

### 4 Modifications

Remark: If not applicable, omit the alphabetic code for modification.  
If more than two modifications are made, combine the applicable codes

Symbol	Location	Shape	Symbol	Location	Shape
B	Segment gap hole		M	Holes plain and threaded	
C	Conical countersunk hole		T	Threaded holes	
H	Through hole		P	Relieved one side	
Q	Diamond Inserted		R	Relieved two sides	
V	Diamond Inverted		Y	Diamond inserted and inverted	



Intelligent Manufacturing will help improve the world

用心产品 创新世界

## Basic Shapes of Diamond/CBN Wheels

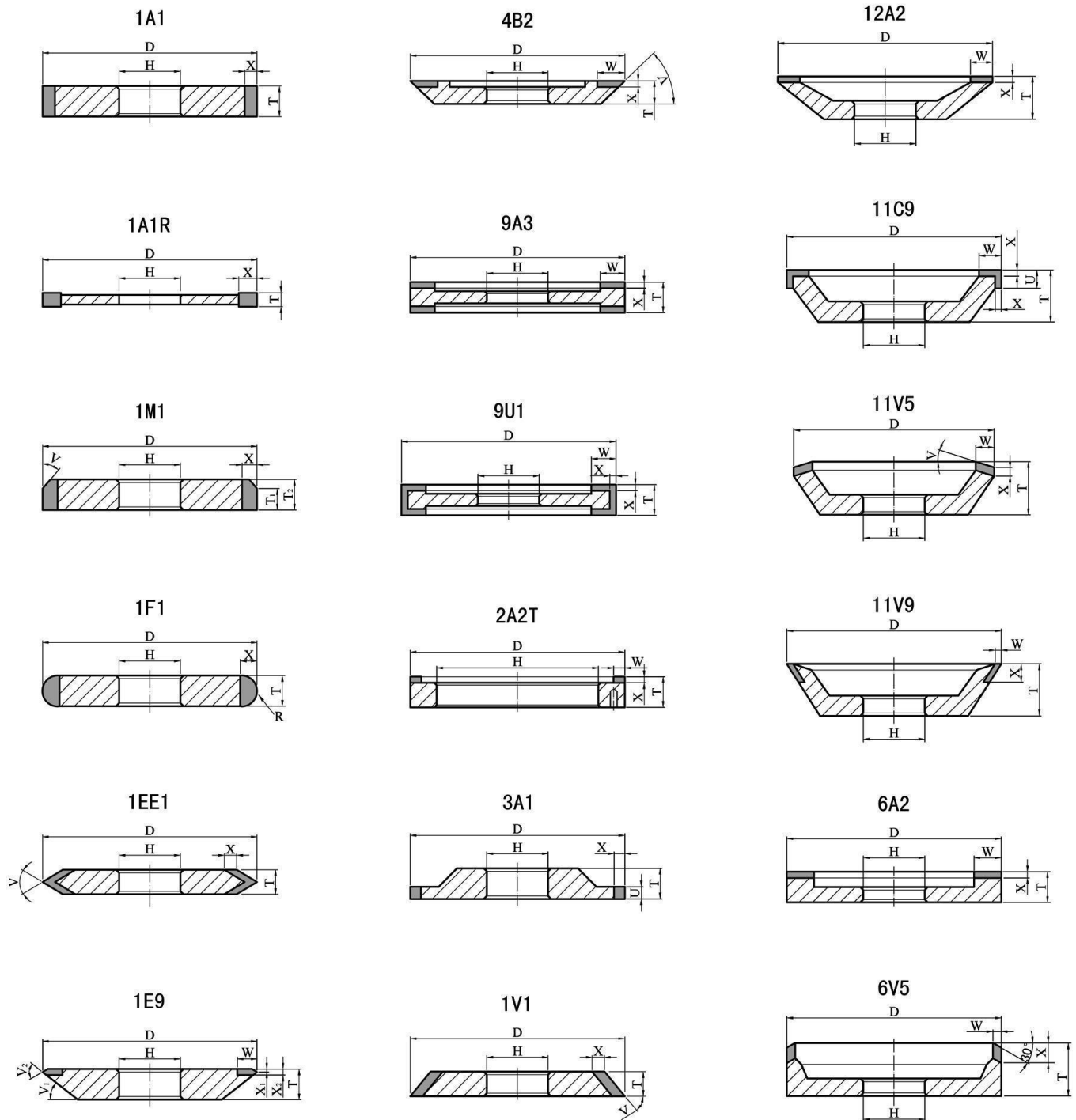



# Intelligent Manufacturing will help improve the world

## 用心产品 创新世界

### CNC - Flute / Polishing

1A1 / 14A1

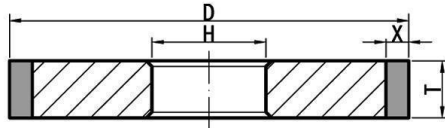

1V1 / 14V1

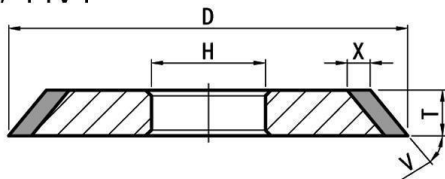

(According to your requirement)

- Diamond or CBN in Periphery
- Available in 75,100,125 Diamond Concentration
- Surface / OD grinding else.

### CNC - Gash / Flute edging

1V1 / 14V1

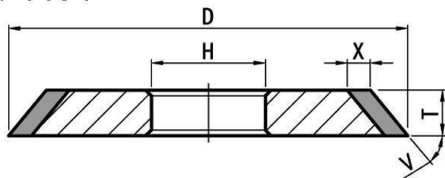

12V9

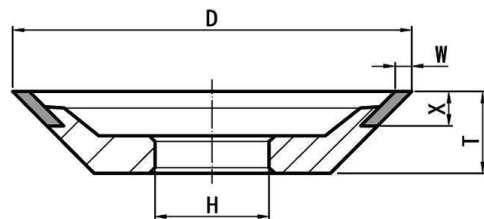

(According to your requirement)

- Diamond or CBN in Pheriphery
- For resharpening the flute and the clearance angel
- Applies to deep grinding of tipped saws else.

### CNC - Relife / Edge clearance

11V9

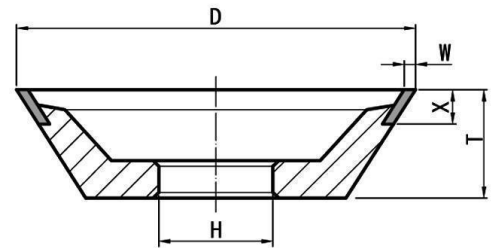

6V5

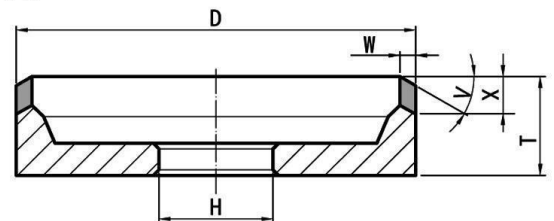

(According to your requirement)

- Flaring Bowl-Diamond or CBN in Pheriphery
- Wheels Used for forming single-lip cutters
- For resharpening the front-milling and the clearance angle else.

1A1 shown in 3D

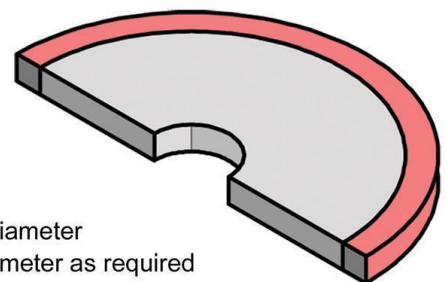

- D = Wheel Diameter
- H = Hole Diameter as required
- T = Wheel Thickness
- X = Diamond Depth

# Intelligent Manufacturing will help improve the world

## 用心产品 创新世界

### Peripheral - Insert Grinding

11A2B

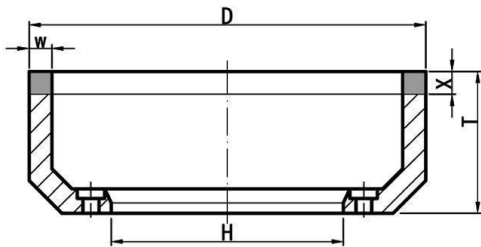

2A2T

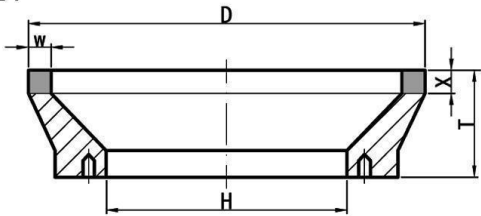

(According to your requirement)

- For Carbide blades and other indexable inserts .
- Available for Wendt, Agathon and the others
- Special Bolt Circle Hole size

### OD- Centerless Grinding

9A1

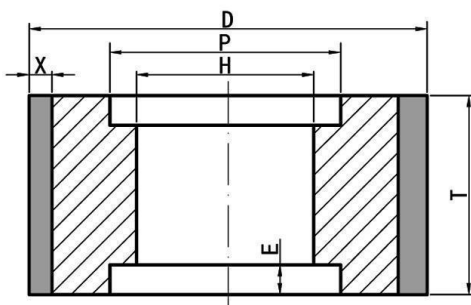

- Grinding Wheel for Wet or Dry Applications
- Special Arbor Hole size upon request

Mounting and balancing service is also available

### Surface Grinding

6A2M

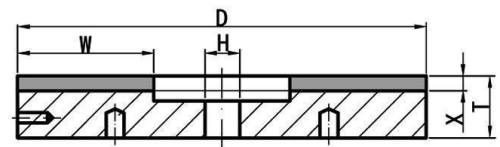

(According to your requirement)

- Available for DAISHO , Peter Wolters etc.
- Applicable to Inserts Plane knives and Piston ring
- with planetary kinematics

### Cutting-Off

1A1R

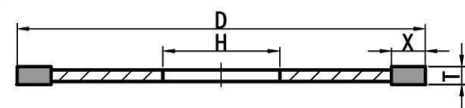

(According to your requirement)

- Straight-Diamond or CBN in Periphery
- Available in 75,100,125 Diamond Concentration
- Special Arbor Hole size upon request

6A2 shown in 3D

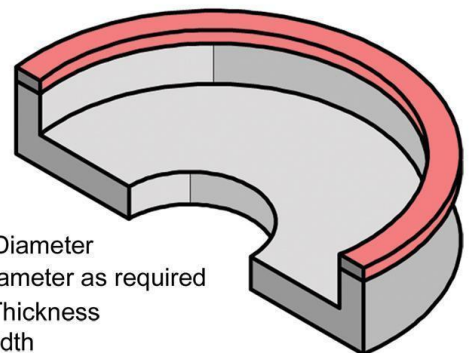

- D = Wheel Diameter
- H = Hole Diameter as required
- T = Wheel Thickness
- W = Rim Width
- X = Diamond Depth



Intelligent Manufacturing will help improve the world

用心产品 创新世界





Intelligent Manufacturing will help improve the world

用心产品 创新世界

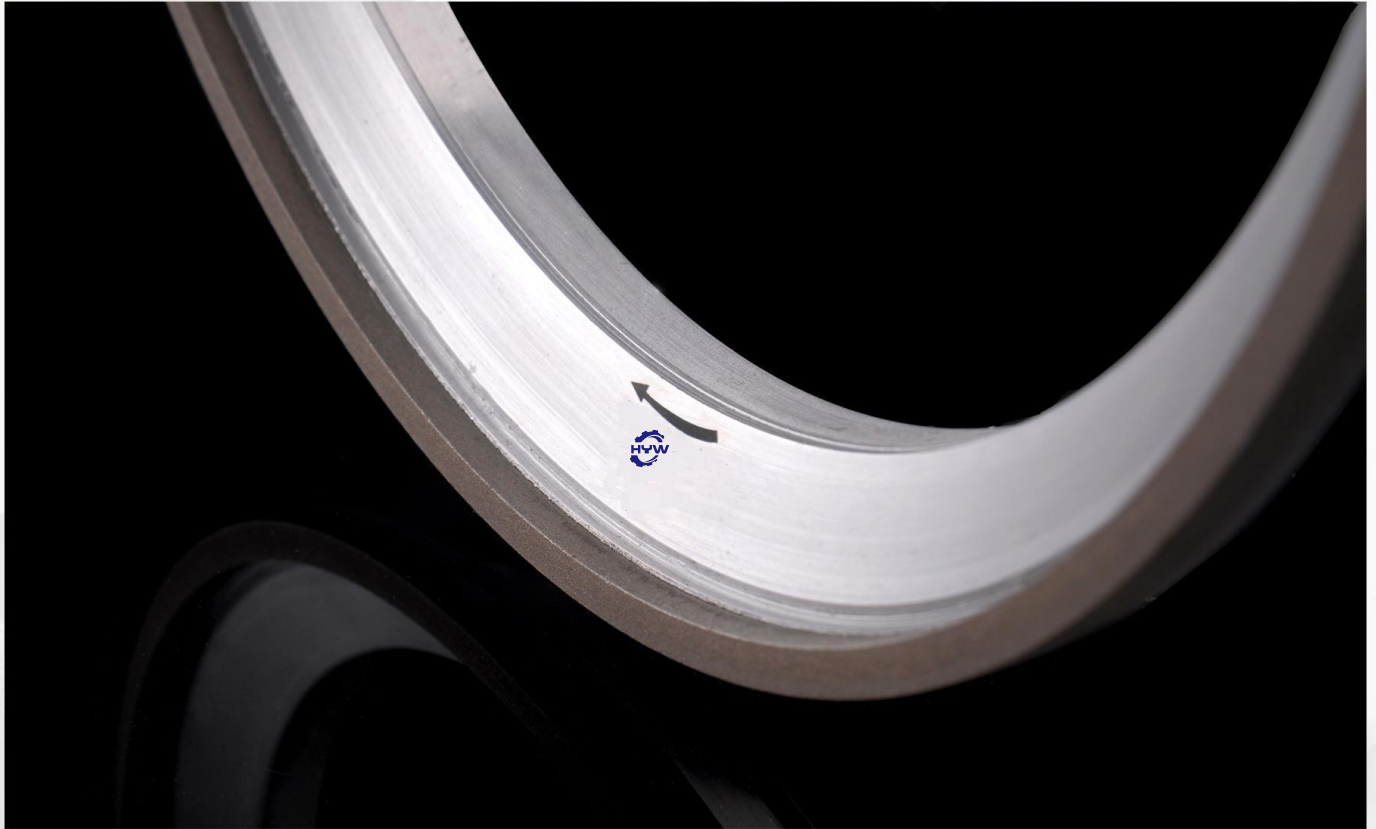

## THE CUSTOMER COMES FIRST

We're aware there are several options for superabrasive grinding solutions, When maximum performance has been realized, our service has to be the best. We realize our sole reason of existence is our customer. Our commitment is to treat everyone that trusts in HYW products with respect, honesty, integrity, and fairness, without discrimination.